

**GEOMETRIC CONFIGURATIONS OF SINGULARITIES FOR
QUADRATIC DIFFERENTIAL SYSTEMS WITH
TOTAL FINITE MULTIPLICITY $m_f = 2$**

JOAN C. ARTÉS, JAUME LLIBRE, DANA SCHLOMIUK, NICOLAE VULPE

ABSTRACT. In this work we consider the problem of classifying all configurations of singularities, both finite and infinite of quadratic differential systems, with respect to the *geometric equivalence relation* defined in [3]. This relation is deeper than the *topological equivalence relation* which does not distinguish between a focus and a node or between a strong and a weak focus or between foci of different orders. Such distinctions are however important in the production of limit cycles close to the foci in perturbations of the systems. The notion of *geometric equivalence relation* of configurations of singularities allows to incorporate all these important geometric features which can be expressed in purely algebraic terms. This equivalence relation is also deeper than the *qualitative equivalence relation* introduced in [17]. The *geometric classification* of all configurations of singularities, finite and infinite, of quadratic systems was initiated in [4] where the classification was done for systems with total multiplicity m_f of finite singularities less than or equal to one. In this article we continue the work initiated in [4] and obtain the *geometric classification* of singularities, finite and infinite, for the subclass of quadratic differential systems possessing finite singularities of total multiplicity $m_f = 2$. We obtain 197 *geometrically distinct* configurations of singularities for this family. We also give here the global bifurcation diagram of configurations of singularities, both finite and infinite, with respect to the *geometric equivalence relation*, for this class of systems. The bifurcation set of this diagram is algebraic. The bifurcation diagram is done in the 12-dimensional space of parameters and it is expressed in terms of polynomial invariants. The results can therefore be applied for any family of quadratic systems in this class, given in any normal form. Determining the geometric configurations of singularities for any such family, becomes thus a simple task using computer algebra calculations.

CONTENTS

1. Introduction and statement of main results	2
2. Compactifications associated to planar polynomial differential systems	7
2.1. Compactification on the sphere and on the Poincaré disk	7
2.2. Compactification on the projective plane	11

2000 *Mathematics Subject Classification*. 58K45, 34C05, 34A34.

Key words and phrases. Quadratic vector fields; infinite and finite singularities; affine invariant polynomials; Poincaré compactification; configuration of singularities; geometric equivalence relation.

©2014 Texas State University - San Marcos.

Submitted November 25, 2013. Published July 18, 2014.

2.3. Assembling data on infinite singularities in divisors of the line at infinity	13
3. Some geometric concepts	16
4. Notation for singularities of polynomial differential systems	27
Semi-elemental points:	28
Nilpotent points:	28
Intricate points:	28
Line at infinity filled up with singularities:	29
5. Invariant polynomials and preliminary results	30
5.1. Affine invariant polynomials associated with infinite singularities	30
5.2. Affine invariant polynomials associated to finite singularities	32
6. Proof of the main theorem	37
6.1. The family of quadratic differential systems with only two distinct complex finite singularities	38
A. Systems with $m = h = 1$.	40
B. Systems with $m = 1, h = 0$.	40
6.2. The family of quadratic differential systems with two real distinct finite singularities which in addition are elemental	43
A. Systems (6.29)	60
B. Systems (6.30)	69
6.3. The family of quadratic differential systems with only one finite singularity which in addition is of multiplicity two	71
Acknowledgments	77
References	77

1. INTRODUCTION AND STATEMENT OF MAIN RESULTS

We consider here differential systems of the form

$$\frac{dx}{dt} = p(x, y), \quad \frac{dy}{dt} = q(x, y), \quad (1.1)$$

where $p, q \in \mathbb{R}[x, y]$, i.e. p, q are polynomials in x, y over \mathbb{R} . We call *degree* of a system (1.1) the integer $m = \max(\deg p, \deg q)$. In particular we call *quadratic* a differential system (1.1) with $m = 2$. We denote here by QS the whole class of real quadratic differential systems.

The study of the class QS has proved to be quite a challenge since hard problems formulated more than a century ago, are still open for this class. It is expected that we have a finite number of phase portraits in QS. Although we have phase portraits for several subclasses of QS, the complete list of phase portraits of this class is not known and attempting to topologically classify these systems, which occur rather often in applications, is a very complex task. This is partly due to the elusive nature of limit cycles and partly to the rather large number of parameters involved. This family of systems depends on twelve parameters but due to the group action of real affine transformations and time homotheties, the class ultimately depends on five parameters which is still a rather large number of parameters. For the moment only subclasses depending on at most three parameters were studied globally, including global bifurcation diagrams (for example [2]). On the other hand we can restrict the study of the whole quadratic class by focusing on specific global features of the

systems in this family. We may thus focus on the global study of singularities and their bifurcation diagram. The singularities are of two kinds: finite and infinite. The infinite singularities are obtained by compactifying the differential systems on the sphere or on the Poincaré disk as defined in Section 2 (see also [14]).

The global study of quadratic vector fields in the neighborhood of infinity was initiated by Coll in [13] where he characterized all the possible phase portraits in a neighborhood of infinity. Later on Nikolaev and Vulpe in [20] classified topologically the singularities at infinity in terms of invariant polynomials. Schlomiuk and Vulpe used geometric concepts defined in [25], and also introduced some new geometric concepts in [26] in order to simplify the invariant polynomials and the classification. To reduce the number of phase portraits in half, in both cases the *topological equivalence relation* was taken to mean the existence of a homeomorphism of the plane carrying orbits to orbits and *preserving or reversing* the orientation. In [5] the authors classified topologically (adding also the distinction between nodes and foci) the whole quadratic class, according to configurations of their finite singularities.

In the topological classification no distinction was made among the various types of foci or saddles, strong or weak of various orders. However these distinctions of an algebraic nature are very important in the study of perturbations of systems possessing such singularities. Indeed, the maximum number of limit cycles which can be produced close to the weak foci in perturbations depends on the orders of the foci.

There are also three kinds of simple nodes as we can see in Figure 1 below where the local phase portraits around the singularities are given.

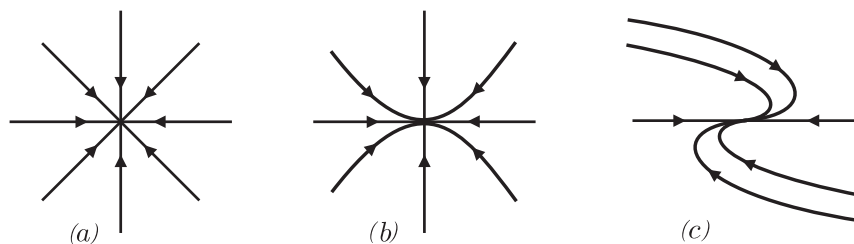

FIGURE 1. Different types of nodes.

In the three phase portraits of Figure 1 the corresponding three singularities are stable nodes. These portraits are topologically equivalent but the solution curves do not arrive at the nodes in the same way. In the first case, any two distinct non-trivial phase curves arrive at the node with distinct slopes. Such a node is called a star node. In the second picture all non-trivial solution curves excepting two of them arrive at the node with the same slope but the two exception curves arrive at the node with a different slope. This is the generic node with two directions. In the third phase portrait all phase curves arrive at the node with the same slope. Here algebraic distinction means that the linearization matrices at these nodes and their eigenvalues, distinguish the nodes in Figure 1, see [27].

We recall that the first and the third types of nodes could produce foci in perturbations and the first type of nodes is also involved in the existence of invariant straight lines of differential systems. For example it can easily be shown that if a

quadratic differential system has two finite star nodes then necessarily the system possesses invariant straight lines of total multiplicity 6.

Furthermore, a generic node at infinity may or may not have the two exceptional curves lying on the line at infinity. This leads to two different situations for the phase portraits. For this reason we split the generic nodes at infinity in two types.

The distinctions among the nilpotent and linearly zero singularities finite or infinite can also be refined, as done in [4, Section 4].

The *geometric equivalence relation* for finite or infinite singularities, introduced in [3] and used in [4], takes into account such distinctions. The concept of *geometric equivalence* of configurations of singularities was defined and discussed in detail in a full section (Section 4) of our paper [4], also in [3]. This concept involves several notions such as “tangent equivalence”, “order equivalence of weak singularities” and “blow-up equivalence”. This last notion is subtle and cannot be described briefly. Therefore we advise the interested reader to consult Section 4 of [4] or of [3].

This equivalence relation is deeper than the *qualitative equivalence relation* introduced by Jiang and Llibre in [17] because it distinguishes among the foci (or saddles) of different orders and among the various types of nodes. This equivalence relation also induces a deeper distinction among the more complicated degenerate singularities.

To distinguish among the foci (or saddles) of various orders we use the algebraic concept of Poincaré-Lyapunov constants. We call strong focus (or strong saddle) a focus (or a saddle) with non-zero trace of the linearization matrix at this point. Such a focus (or saddle) will be considered to have the order zero. A focus (or saddle) with trace zero is called a weak focus (weak saddle). For details on Poincaré-Lyapunov constants and weak foci we refer to [24], [18].

Algebraic information may not be significant for the local (topological) phase portrait around a singularity. For example, topologically there is no distinction between a focus and a node or between a weak and a strong focus. However, as indicated before, algebraic information plays a fundamental role in the study of perturbations of systems possessing such singularities.

The following is a legitimate question:

How far can we go in the global theory of quadratic (or more generally polynomial) vector fields by using mainly algebraic means?

For certain subclasses of quadratic vector fields the full description of the phase portraits as well as of the bifurcation diagrams can be obtained using only algebraic tools. Examples of such classes are:

- the quadratic vector fields possessing a center [34, 23, 37, 21];
- the quadratic Hamiltonian vector fields [1, 6];
- the quadratic vector fields with invariant straight lines of total multiplicity at least four [27, 28];
- the planar quadratic differential systems possessing a line of singularities at infinity [29];
- the quadratic vector fields possessing an integrable saddle [7].
- the family of Lotka-Volterra systems [30, 31], once we assume Bautin’s analytic result saying that such systems have no limit cycles;

In the case of other subclasses of the quadratic class QS, such as the subclass of systems with a weak focus of order 3 or 2 (see [18, 2]) the bifurcation diagrams were obtained by using an interplay of algebraic, analytic and numerical methods.

These subclasses were of dimensions 2 and 3 modulo the action of the affine group and time rescaling. So far no 4-dimensional subclasses of QS were studied globally so as to also produce bifurcation diagrams and such problems are very difficult due to the number of parameters as well as the increased complexities of these classes.

Although we now know that in trying to understand these systems, there is a limit to the power of algebraic methods, these methods have not been used far enough. For example the global classification of singularities, finite and infinite, using the *geometric equivalence relation*, can be done by using only algebraic methods. The first step in this direction was done in [3] where the study of *the whole class* QS, according to the configurations of the singularities at infinity was obtained by using only algebraic methods. This classification was done with respect to the *geometric equivalence relation* of configurations of singularities. Our work in [3] can be extended so as to also include the finite singularities for the whole class QS. To obtain the global *geometric classification* of all possible configurations of singularities, finite and infinite, of the class QS, by purely algebraic means is a long term goal since we expect to finally obtain over 1000 distinct configurations of singularities. In [4] we initiated the work on this project by studying the configurations of singularities for the subclass of QS for which the total multiplicity m_f of finite singularities is less than or equal to one.

Our goal here is to continue this work by *geometrically* classifying the configurations of all singularities with total finite multiplicity $m_f = 2$ for systems in QS.

We recall here below the notion of *geometric configuration of singularities* defined in [4] for both finite and infinite singularities. We distinguish two cases:

(1) If we have a finite number of infinite singular points and a finite number of finite singularities we call *geometric configuration of singularities*, finite and infinite, the set of all these singularities each endowed with its own multiplicity together with their local phase portraits endowed with additional geometric structure involving the concepts of tangent, order and blow-up equivalences defined in Section 4 of [4] and using the notations described here in Section 4.

(2) If the line at infinity $Z = 0$ is filled up with singularities, in each one of the charts at infinity $X \neq 0$ and $Y \neq 0$, the corresponding system in the Poincaré compactification (see Section 2) is degenerate and we need to do a rescaling of an appropriate degree of the system, so that the degeneracy be removed. The resulting systems have only a finite number of singularities on the line $Z = 0$. In this case we call *geometric configuration of singularities*, finite and infinite, the union of the set of all points at infinity (they are all singularities) with the set of finite singularities - taking care to single out the singularities at infinity of the “reduced” system, taken together with the local phase portraits of finite singularities endowed with additional geometric structure as above and the local phase portraits of the infinite singularities of the reduced system.

We define the following affine invariants: Let Σ_C be the sum of the finite orders of weak singularities (foci or weak saddles) in a configuration C of a quadratic system and let M_C be the maximum finite order of a weak singularity in a configuration C of a quadratic system. Clearly Σ_C and M_C are affine invariants. Let Σ_2 (respectively M_2) be the maximum of all Σ_C (respectively M_C) for the subclass of QS with $m_f = 2$.

In stating our theorem we take care to include the results about the configurations containing centers and integrable saddles or containing weak singularities which are foci or saddles, since these singularities are especially important having the potential of producing limit cycles in perturbations. We use the notation introduced in [4] denoting by $f^{(i)}$, $s^{(i)}$, the weak foci and the weak saddles of order i and by c and $\$$ the centers and integrable saddles.

Our results are stated in the following theorem.

Theorem 1.1. (A) *We consider here all configurations of singularities, finite and infinite, of quadratic vector fields with finite singularities of total multiplicity $m_f = 2$. These configurations are classified in Diagrams 1–3 according to the geometric equivalence relation. We have 197 geometric distinct configurations of singularities, finite and infinite. More precisely 16 configurations with two distinct complex finite singularities; 151 configurations with two distinct real finite singularities and 30 with one real finite singularity of multiplicity 2.*

(B) *For the subclass of QS with $m_f = 2$ we have $\Sigma_2 = 2 = M_2$. There are only 6 configurations of singularities with finite weak singular points with $\Sigma_C = 2$. These have the following combinations of finite singularities: $f^{(1)}, f^{(1)}$; $s^{(1)}, s^{(1)}$; $s^{(2)}, n$; $s^{(2)}, n^d$; $s^{(2)}, f$; $f^{(2)}, s$.*

There are 7 configurations of singularities with finite weak singular points with $\Sigma_C = 1$. These have the following combinations of finite singularities: $f^{(1)}, n$; $f^{(1)}, n^d$; $f^{(1)}, s$; $f^{(1)}, f$; $s^{(1)}, n$; $s^{(1)}, n^d$; $s^{(1)}, f$.

There are 19 configurations containing a center or an integrable saddle, only 6 of them with a center. There are 8 distinct couples of finite singularities occurring in these configurations. They are: $c, \$$; c, s ; $\$, \$$; $\$, s$; $\$, n$; $\$, n^$; $\$, n^d$; $\$, f$.*

(C) *Necessary and sufficient conditions for each one of the 197 different equivalence classes can be assembled from these diagrams in terms of 31 invariant polynomials with respect to the action of the affine group and time rescaling, given in Section 5.*

(D) *The Diagrams 1–3 actually contain the global bifurcation diagram in the 12-dimensional space of parameters, of the global configurations of singularities, finite and infinite, of this family of quadratic differential systems.*

(E) *Of all the phase portraits in the neighborhood of the line at infinity, which are here given in Figure 2, six are not realized in the family of systems with $m_f = 2$. They are Configs 17; 19; 30; 32; 43; 44. (see Figure 2).*

Remark 1.2. The diagrams are constructed using the invariant polynomials μ_0, μ_1, \dots which are defined in Section 5. In the diagrams conditions on these invariant polynomials are listed on the left side of the diagrams, while the specific geometric configurations appear on the right side of the diagram. These configurations are expressed using the notation described in Section 4.

The invariants and comitants of differential equations used for proving our main results are obtained following the theory of algebraic invariants of polynomial differential systems, developed by Sibirsky and his disciples (see for instance [32, 35, 22, 8, 12]).

Remark 1.3. We note that the geometric equivalence relation for configurations is much deeper than the topological equivalence. Indeed, for example the topological equivalence does not distinguish between the following three configurations

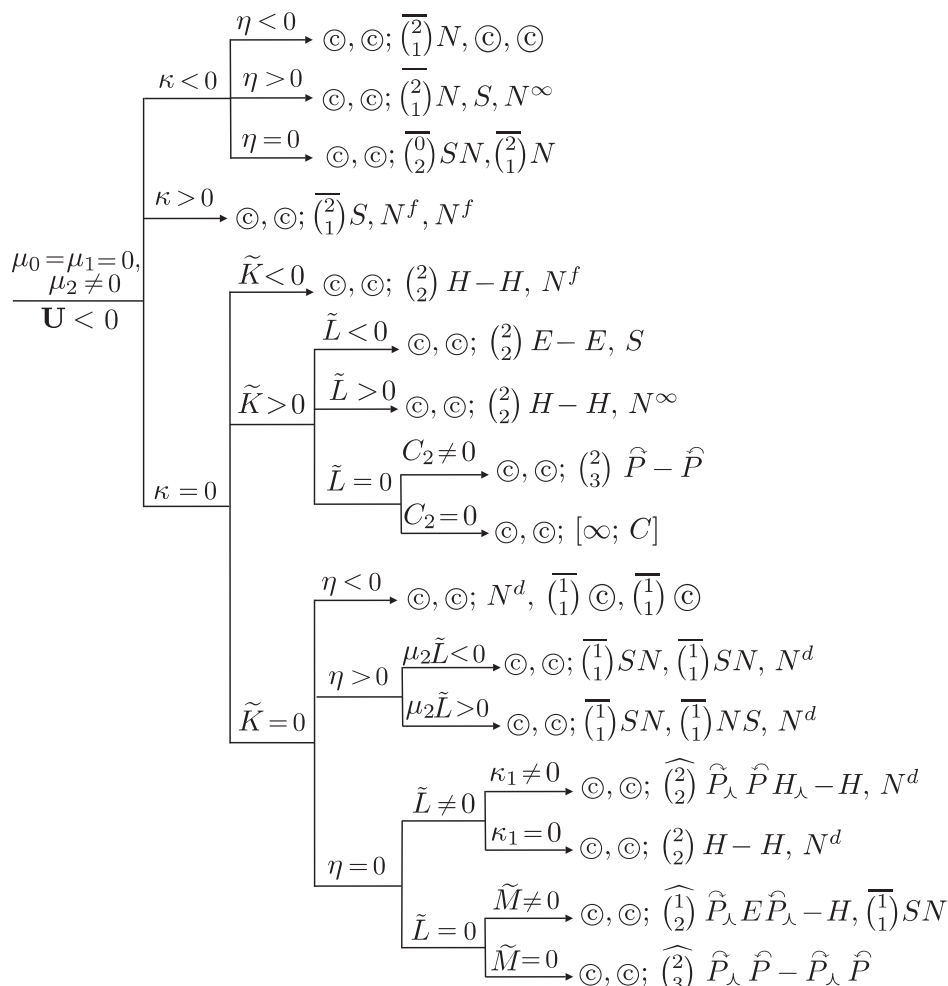

DIAGRAM 1. Global configurations: the case $\mu_0 = \mu_1 = 0, \mu_2 \neq 0, \mathbf{U} < 0$.

which are geometrically non-equivalent: $n, f, SN, \odot, \odot; n, f^{(1)}, SN, \odot, \odot$ and $n^d, f^{(1)}, SN, \odot, \odot$ where n means a singularity which is a node, capital letters indicate points at infinity, \odot in case of a complex point and SN a saddle-node at infinity.

2. COMPACTIFICATIONS ASSOCIATED TO PLANAR POLYNOMIAL DIFFERENTIAL SYSTEMS

2.1. Compactification on the sphere and on the Poincaré disk. Planar polynomial differential systems (1.1) can be compactified on the sphere. For this we consider the affine plane of coordinates (x, y) as being the plane $Z = 1$ in \mathbb{R}^3 with the origin located at $(0, 0, 1)$, the x -axis parallel with the X -axis in \mathbb{R}^3 , and the y -axis parallel to the Y -axis. We use a central projection to project this plane on the sphere as follows: for each point $(x, y, 1)$ we consider the line joining the

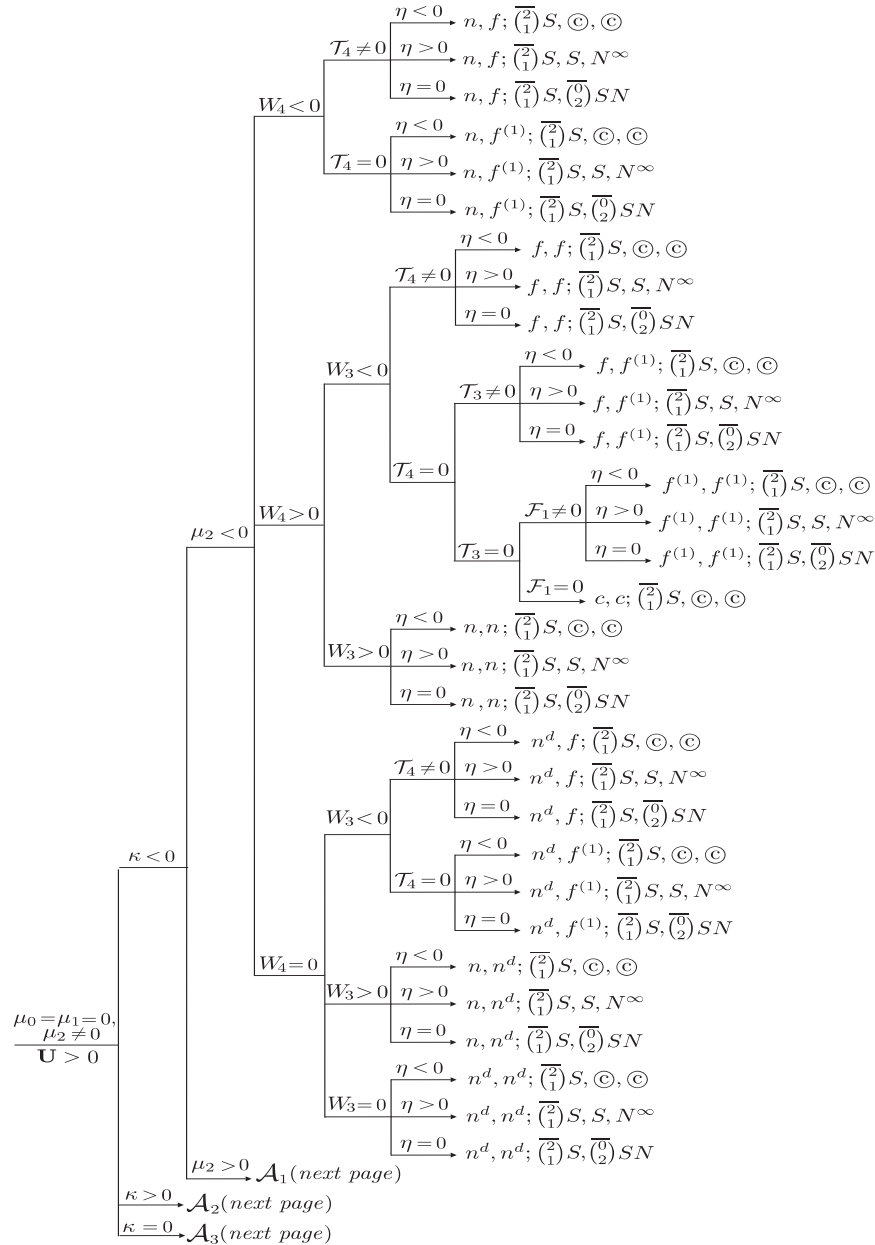

DIAGRAM 2. Global configurations: the case $\mu_0 = \mu_1 = 0, \mu_2 \neq 0, \mathbf{U} > 0$.

origin with $(x, y, 1)$. This line intersects the sphere in two points $P_1 = (X, Y, Z)$ and $P_2 = (-X, -Y, -Z)$ where $(X, Y, Z) = (1/\sqrt{x^2 + y^2 + 1})(x, y, 1)$. The applications $(x, y) \mapsto P_1$ and $(x, y) \mapsto P_2$ are bianalytic and associate to a vector field on the plane (x, y) an analytic vector field Ψ on the upper hemisphere and also an analytic vector field Ψ' on the lower hemisphere. A theorem stated by Poincaré and proved

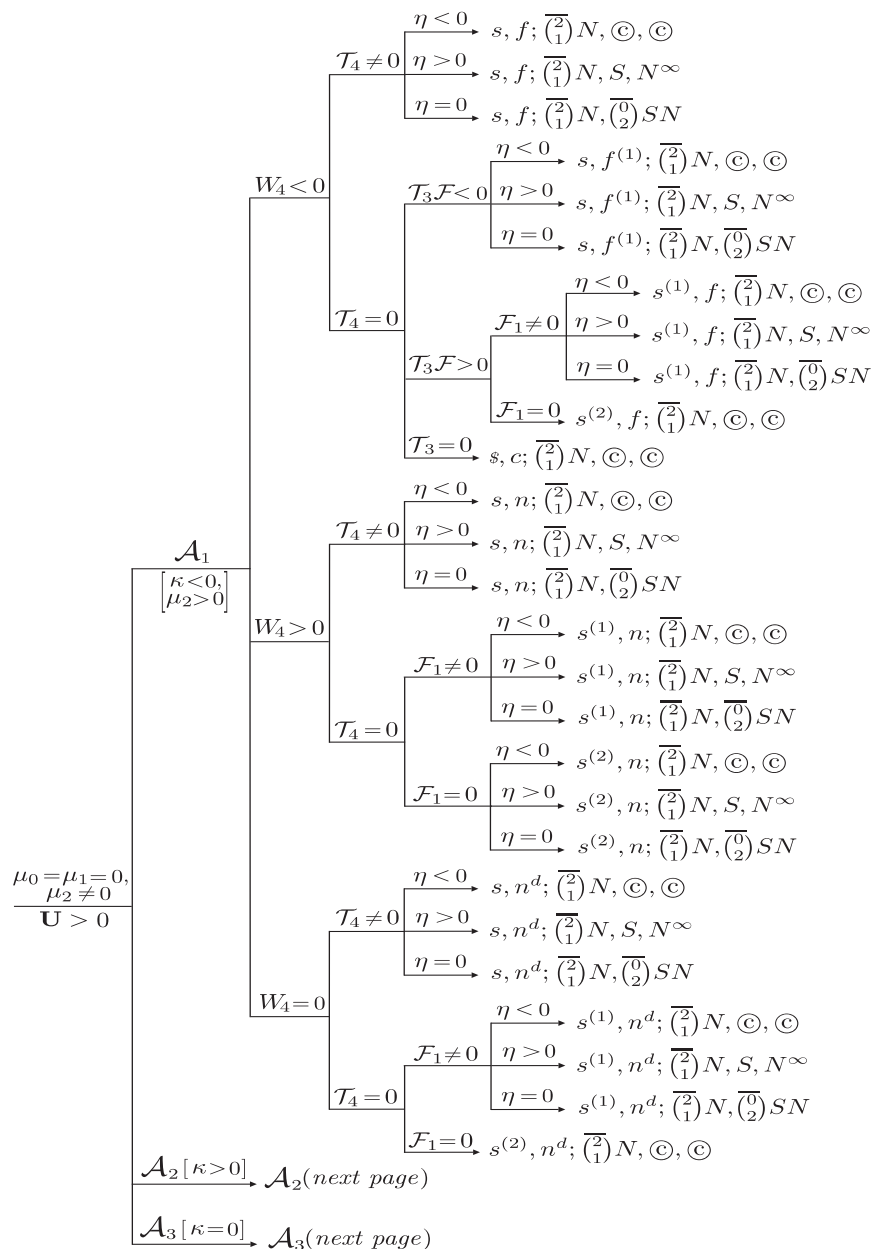

DIAGRAM 2 (continued). Global configurations: the case $\mu_0 = \mu_1 = 0, \mu_2 \neq 0, \mathbf{U} > 0$.

in [15] says that there exists an analytic vector field Θ on the whole sphere which simultaneously extends the vector fields on the two hemispheres. By the *Poincaré compactification on the sphere* of a planar polynomial vector field we mean the restriction Ψ of the vector field Θ to the union of the upper hemisphere with the equator. For more details we refer to [14]. The vertical projection of Ψ on the plane $Z = 0$ gives rise to an analytic vector field Φ on the unit disk of this plane. By

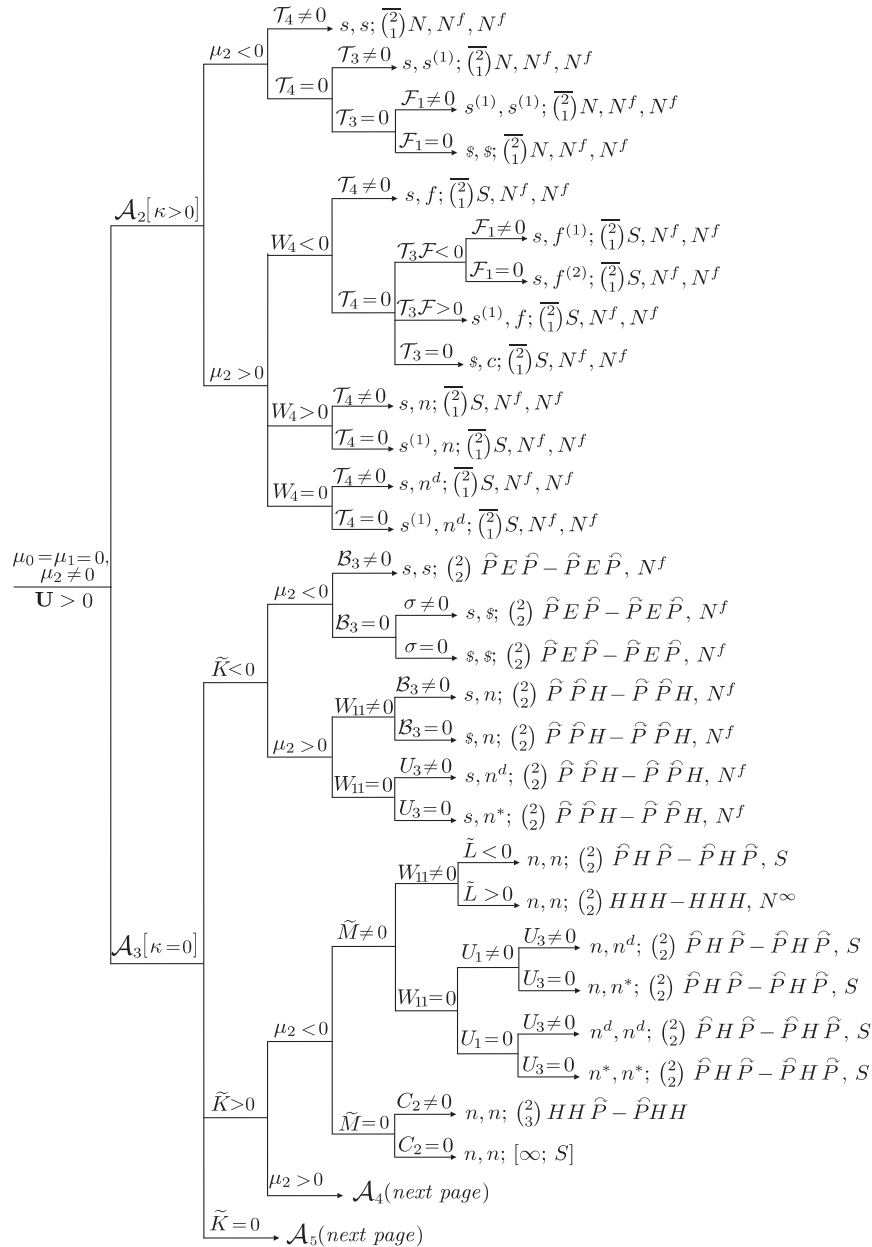

DIAGRAM 2 (continued). Global configurations: the case $\mu_0 = \mu_1 = 0, \mu_2 \neq 0, \mathbf{U} > 0$.

the compactification on the Poincaré disk of a planar polynomial vector field we understand the vector field Φ . By a singular point at infinity of a planar polynomial vector field we mean a singular point of the vector field Ψ which is located on the equator of the sphere, respectively a singular point of the vector field Φ located on the boundary circle of the Poincaré disk.

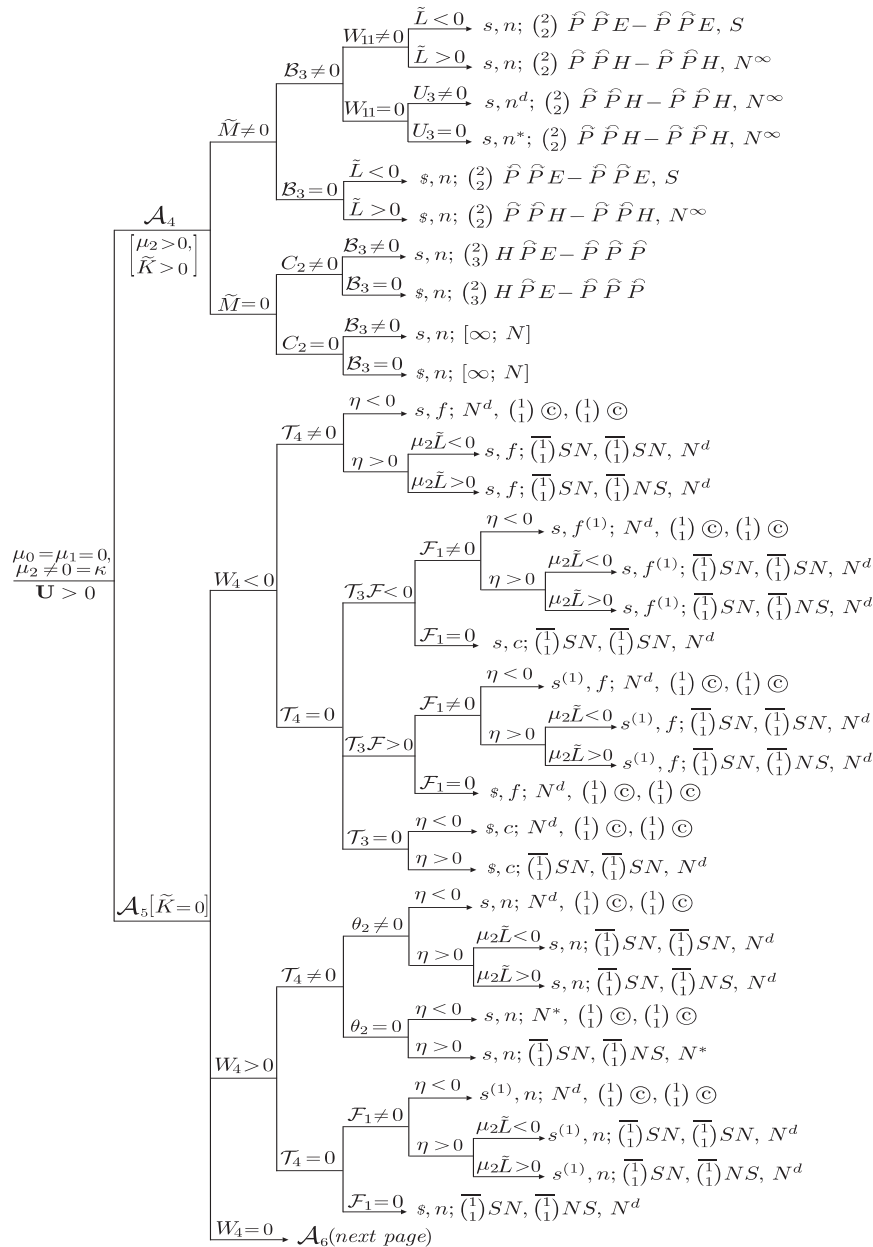

DIAGRAM 2 (continued). Global configurations: the case $\mu_0 = \mu_1 = 0, \mu_2 \neq 0, \mathbf{U} > 0$.

2.2. Compactification on the projective plane. To polynomial system (1.1) we can associate a differential equation $\omega_1 = q(x, y)dx - p(x, y)dy = 0$. Since the differential system (1.1) is with real coefficients, we may associate to it a foliation with singularities on the real, respectively complex, projective plane as indicated below. The equation $\omega_1 = 0$ defines a foliation with singularities on the real or complex plane depending if we consider the equation as being defined over the

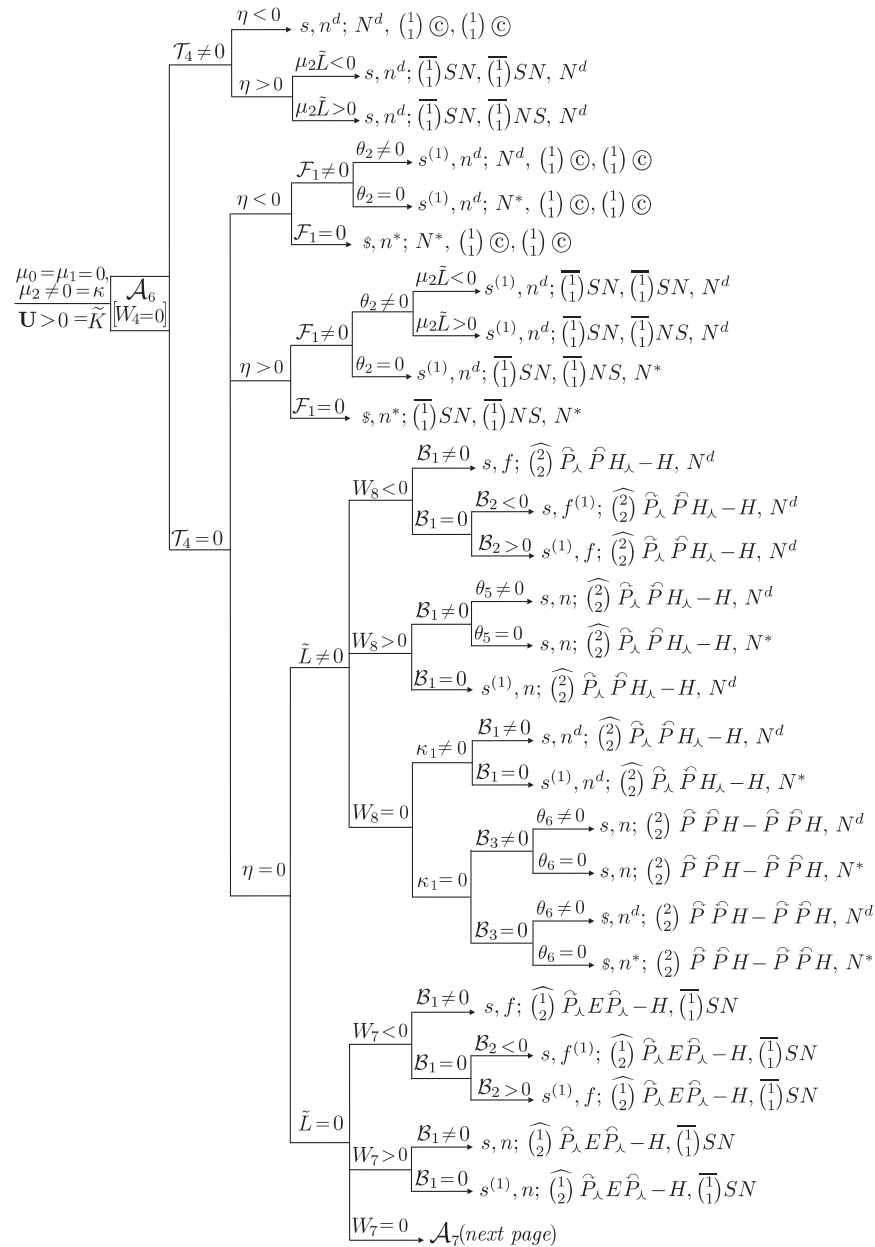

DIAGRAM 2 (continued). Global configurations: the case $\mu_0 = \mu_1 = 0, \mu_2 \neq 0, \mathbf{U} > 0$.

real or complex affine plane. It is known that we can compactify these foliations with singularities on the real respectively complex projective plane. In the study of real planar polynomial vector fields, their associated complex vector fields and their singularities play an important role. In particular such a vector field could have complex, non-real singularities, by this meaning singularities of the associated

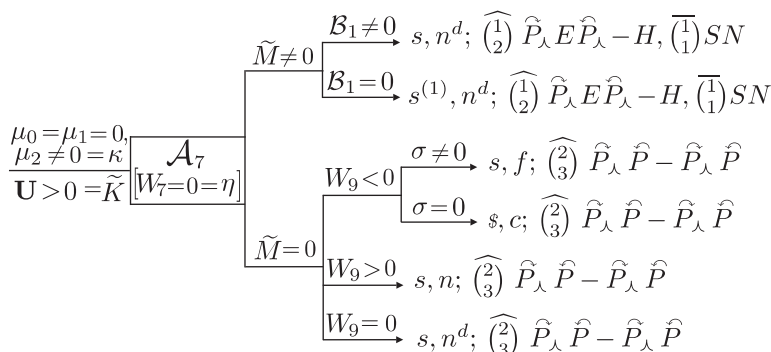

DIAGRAM 2 (continued). Global configurations: the case $\mu_0 = \mu_1 = 0, \mu_2 \neq 0, \mathbf{U} > 0$.

complex vector field. We briefly recall below how these foliations with singularities are defined.

The application $\Upsilon : \mathbb{K}^2 \rightarrow P_2(\mathbb{K})$ defined by $(x, y) \mapsto [x : y : 1]$ is an injection of the plane \mathbb{K}^2 over the field \mathbb{K} into the projective plane $P_2(\mathbb{K})$ whose image is the set of $[X : Y : Z]$ with $Z \neq 0$. If \mathbb{K} is \mathbb{R} or \mathbb{C} this application is an analytic injection. If $Z \neq 0$ then $(\Upsilon)^{-1}([X : Y : Z]) = (x, y)$ where $(x, y) = (X/Z, Y/Z)$. We obtain a map $i : \mathbb{K}^3 \setminus \{Z = 0\} \rightarrow \mathbb{K}^2$ defined by $[X : Y : Z] \mapsto (X/Z, Y/Z)$.

Considering that $dx = d(X/Z) = (ZdX - XdZ)/Z^2$ and $dy = (ZdY - YdZ)/Z^2$, the pull-back of the form ω_1 via the map i yields the form

$$i_*(\omega_1) = q(X/Z, Y/Z)(ZdX - XdZ)/Z^2 - p(X/Z, Y/Z)(ZdY - YdZ)/Z^2$$

which has poles on $Z = 0$. Then the form $\omega = Z^{m+2}i_*(\omega_1)$ on $K^3 \setminus \{Z = 0\}$, K being \mathbb{R} or \mathbb{C} and m being the degree of systems (1.1) yields the equation $\omega = 0$:

$$A(X, Y, Z)dX + B(X, Y, Z)dY + C(X, Y, Z)dZ = 0 \tag{2.1}$$

on $K^3 \setminus \{Z = 0\}$ where A, B, C are homogeneous polynomials over K with

$$\begin{aligned} A(X, Y, Z) &= ZQ(X, Y, Z), & Q(X, Y, Z) &= Z^m q(X/Z, Y/Z), \\ B(X, Y, Z) &= ZP(X, Y, Z), & P(X, Y, Z) &= Z^m p(X/Z, Y/Z), \\ C(X, Y, Z) &= YP(X, Y, Z) - XQ(X, Y, Z). \end{aligned}$$

The equation $AdX + BdY + CdZ = 0$ defines a foliation F with singularities on the projective plane over K with K either \mathbb{R} or \mathbb{C} . The *points at infinity* of the foliation defined by $\omega_1 = 0$ on the affine plane are the points $[X : Y : 0]$ and the line $Z = 0$ is called the *line at infinity* of the foliation with singularities generated by $\omega_1 = 0$.

The singular points of the foliation F are the solutions of the three equations $A = 0, B = 0, C = 0$. In view of the definitions of A, B, C it is clear that the singular points at infinity are the points of intersection of $Z = 0$ with $C = 0$.

2.3. Assembling data on infinite singularities in divisors of the line at infinity. In the previous sections we have seen that there are two types of multiplicities for a singular point p at infinity: one expresses the maximum number m of infinite singularities which can split from p , in small perturbations of the system and the other expresses the maximum number m' of finite singularities which can

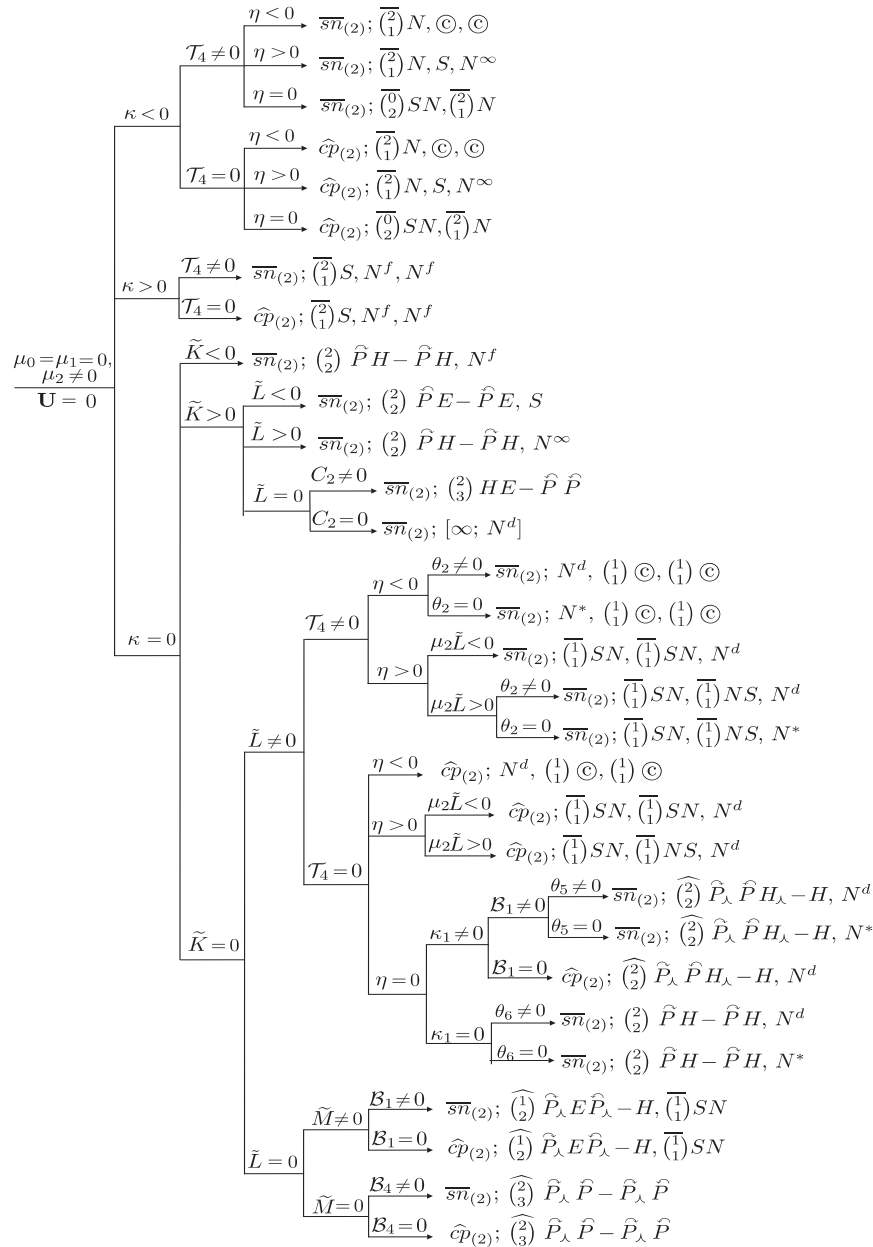

DIAGRAM 3. Global configurations: the case $\mu_0 = \mu_1 = 0, \mu_2 \neq 0, \mathbf{U} = 0$.

split from p , in small perturbations of the system. We shall use a column $(m', m)^t$ to indicate this situation.

We are interested in the global picture which includes *all* singularities at infinity. Therefore we need to assemble the data for individual singularities in a convenient,

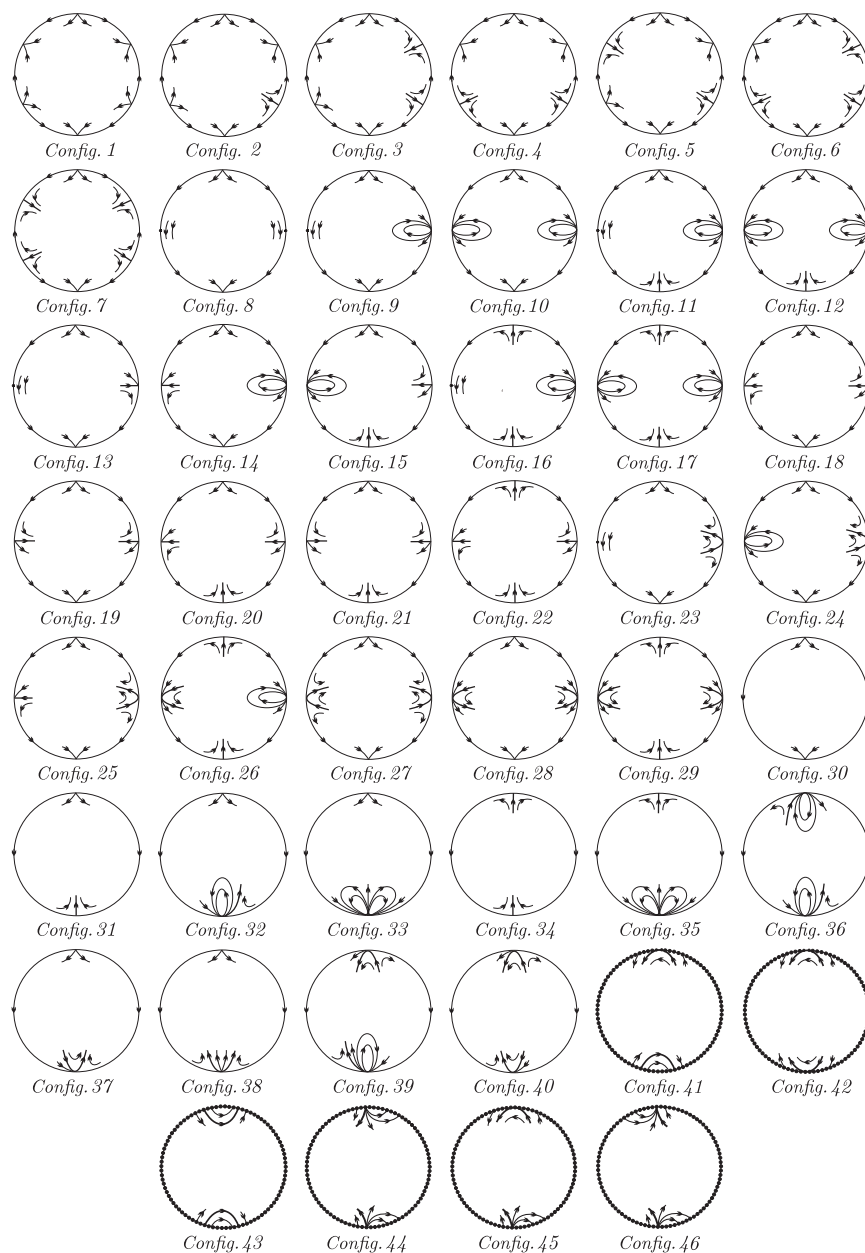

FIGURE 2. Topologically distinct local configurations of ISPs ([26],[29]).

precise way. To do this we use for this situation the notion of *cycle* on an algebraic variety as indicated in [21] and which was used in [18] as well as in [26].

We briefly recall here the definition of cycle. Let V be an irreducible algebraic variety over a field \mathbb{K} . A *cycle* of dimension r or r -*cycle* on V is a formal sum $\sum_W n_W W$, where W is a subvariety of V of dimension r which is not contained in the singular locus of V , $n_W \in \mathbb{Z}$, and only a finite number of the coefficients n_W are

non-zero. The *degree* $\deg(J)$ of a cycle J is defined by $\sum_W n_W$. An $(n-1)$ -cycle is called a *divisor* on V . These notions were used for classification purposes of planar quadratic differential systems in [21, 18, 26].

To system (1.1) we can associate two divisors on the line at infinity $Z = 0$ of the complex projective plane: $D_S(P, Q; Z) = \sum_w I_w(P, Q)w$ and $D_S(C, Z) = \sum_w I_w(C, Z)w$ where $w \in \{Z = 0\}$ and where by $I_w(F, G)$ we mean the intersection multiplicity at w of the curves $F(X, Y, Z) = 0$ and $G(X, Y, Z) = 0$, with F and G homogeneous polynomials in X, Y, Z over \mathbb{C} . For more details see [18].

Following [26] we assemble the above two divisors on the line at infinity into just one but with values in the ring \mathbb{Z}^2 :

$$D_S = \sum_{w \in \{Z=0\}} \begin{pmatrix} I_w(P, Q) \\ I_w(C, Z) \end{pmatrix} w.$$

This divisor encodes the total number of singularities at infinity of a system (1.1) as well as the two kinds of multiplicities which each singularity has. The meaning of these two kinds of multiplicities are described in the definition of the two divisors $D_S(P, Q; Z)$ and $D_S(C, Z)$ on the line at infinity.

3. SOME GEOMETRIC CONCEPTS

Firstly we recall some terminology.

We call *elemental* a singular point with its both eigenvalues not zero.

We call *semi-elemental* a singular point with exactly one of its eigenvalues equal to zero.

We call *nilpotent* a singular point with both its eigenvalues zero but with its Jacobian matrix at this point not identically zero.

We call *intricate* a singular point with its Jacobian matrix identically zero.

The *intricate* singularities are usually called in the literature *linearly zero*. We use here the term *intricate* to indicate the rather complicated behavior of phase curves around such a singularity.

In this section we use the same concepts we considered in [3] and [4] such as *orbit γ tangent to a semi-line L at p , well defined angle at p , characteristic orbit at a singular point p , characteristic angle at a singular point, characteristic direction at p* . Since these are basic concepts for the notion of *geometric equivalence relation* we recall here these notions as well as a few others.

We assume that we have an isolated singularity p . Suppose that in a neighborhood U of p there is no other singularity. Consider an orbit γ in U defined by a solution $\Gamma(t) = (x(t), y(t))$ such that $\lim_{t \rightarrow +\infty} \Gamma(t) = p$ (or $\lim_{t \rightarrow -\infty} \Gamma(t) = p$). For a fixed t consider the unit vector $C(t) = \frac{(\Gamma(t) - p)}{\|\Gamma(t) - p\|}$. Let L be a semi-line ending at p . We shall say that *the orbit γ is tangent to a semi-line L at p* if $\lim_{t \rightarrow +\infty} C(t)$ (or $\lim_{t \rightarrow -\infty} C(t)$) exists and L contains this limit point on the unit circle centered at p . In this case we call *well defined angle of Γ at p* the angle between the positive x -axis and the semi-line L measured in the counterclockwise sense. We may also say that *the solution curve $\Gamma(t)$ tends to p with a well defined angle*. A *characteristic orbit at a singular point p* is the orbit of a solution curve $\Gamma(t)$ which tends to p with a well defined angle. We call *characteristic angle at the singular point p* a well defined angle of a solution curve $\Gamma(t)$. The line through p extending the semi-line L is called a *characteristic direction*.

Assume the singularity is placed at $(0,0)$. Then the polynomial $PCD(x,y) = yp_m(x,y) - xq_m(x,y)$, where m is the starting degree of a polynomial differential system of the form (1.1), is called the *Polynomial of Characteristic Directions* of (1.1). In fact in case $PCD(x,y) \not\equiv 0$ the factorization of $PCD(x,y)$ gives the characteristic directions at the origin.

If a singular point has an infinite number of characteristic directions, we will call it a *star-like* point.

It is known that the neighborhood of any isolated singular point of a polynomial vector field, which is not a focus or a center, is formed by a finite number of sectors which could only be of three types: parabolic, hyperbolic and elliptic (see [14]). It is also known that any degenerate singular point (nilpotent or intricate) can be desingularized by means of a finite number of changes of variables, called blow-up's, into elementary singular points (for more details see the Section on blow-up in [3] or [14]).

Consider the three singular points given in Figure 3. All three are topologically equivalent and their neighborhoods can be described as having two elliptic sectors and two parabolic ones. But we can easily detect some geometric features which distinguish them. For example (a) and (b) have three characteristic directions and (c) has only two. Moreover in (a) the solution curves of the parabolic sectors are tangent to only one characteristic direction and in (b) they are tangent to two characteristic directions. All these properties can be determined algebraically.

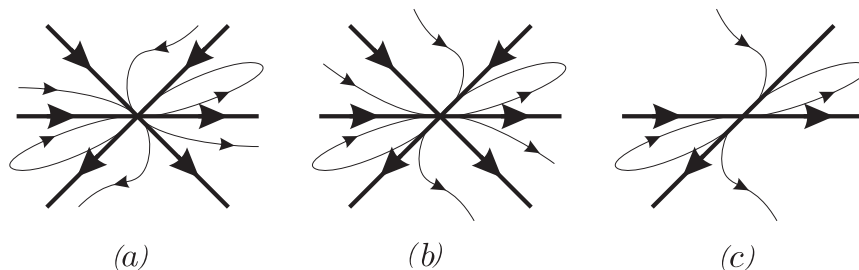

FIGURE 3. Some topologically equivalent singular points.

The usual definition of a sector is of topological nature and it is local with respect to a neighborhood around the singular point. We work with a new notion, namely of *geometric local sector*, introduced in [3] which distinguishes the phase portraits of Figure 3. As we shall later see this notion is characterized in algebraic terms.

We begin with the elemental singular points having characteristic directions. These are either two-directions nodes, one-direction nodes, star nodes or saddles. The first three cases are distinguished algebraically using their eigenvalues (see Figure 1). In the case of saddles the notion of geometric local sector coincides with usual notion of topological sector.

We consider now the semi-elemental singular points. These could be saddles, nodes or saddle-nodes. Each saddle has four separatrices and four hyperbolic sectors. Here again we call geometric local sector any one of these hyperbolic sectors and we call *borsec* (contraction of border with sector) any one of the four separatrices.

A semi-elemental node has two characteristic directions generating four half lines. For each one of these half lines there exists at least one orbit tangent to that half line and we pick an orbit tangent to that half line. Removing these four orbits together with the singular point, we are left with four sectors which we call *geometric local sectors* and we call *borsecs* these four orbits.

Consider now a semi-elemental saddle-node. Such a singular point has three separatrices and three topological sectors, two hyperbolic ones and one parabolic sector. Such a singular point has four characteristic half lines and one of them separates the parabolic sector in two. By removing an orbit tangent to a half line for each one of the half lines as well as the singular point we obtain four sectors which we call geometric local sectors. We call borsecs these four orbits.

We now proceed to extend the notion of geometric local sector and of borsec for nilpotent and intricate singular points.

The introduction of the concept of borsec in the general case will play a role in distinguishing a semi-elemental saddle-node from an intricate saddle-node such as the one indicate in Figure 4. In the semi-elemental saddle-node all orbits inside the parabolic sector are tangent to the same half-line but in the saddle-node of Figure 4 the orbits in the parabolic sector are not all tangent to the same half-line. The orbits in this parabolic sector are of three kinds: the ones tangent to separatrix (a), the ones tangent to separatrix (c) and a single orbit which is tangent to other half-line of the characteristic direction defined by separatrix (b). In this case this last orbit is called the borsec. The other three borsecs are separatrices as in the case of the semi-elemental saddle-node.

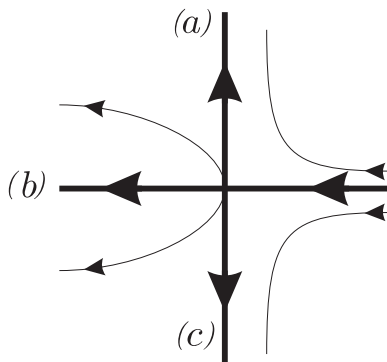

FIGURE 4. Local phase portrait of a non semi-elemental saddle-node.

To extend the notion of geometric local sector and of borsec for nilpotent and intricate singular points we start by introducing some terminology.

Let δ be the border of a sufficiently small open disc D centered at point p so that δ intersects all the elliptic, parabolic and hyperbolic sectors of a nilpotent or intricate singular point p .

Consider a solution $\Gamma : (a, b) \rightarrow \mathbb{R}^2$ where (a, b) is its maximal interval of definition and let γ be the orbit of Γ , i.e. $\gamma = \{\Gamma(t) \mid t \in (a, b)\}$. We call *half orbit* of γ at a singular point p a subset $\gamma' \subseteq \gamma$ such that there exists $t_1 \in (a, b)$ for which we have either $\gamma' = \{\Gamma(t) \mid t \in (a, t_1)\}$ in which case we have $a = -\infty$, $\lim_{t \rightarrow -\infty} \Gamma(t) = p$,

$\Gamma(t_1) \in \delta$ and $\Gamma(t) \in D$ for $t \in (-\infty, t_1)$, or $\gamma' = \{\Gamma(t) \mid t \in (t_1, b)\}$, $b = +\infty$, $\lim_{t \rightarrow +\infty} \Gamma(t) = p$, $\Gamma(t_1) \in \delta$ and $\Gamma(t) \in D$ for $t \in (t_1, \infty)$.

We note that in the case of elliptic sectors there may exist orbits which are divided exactly in two half orbits.

Let $\Omega_p = \{\gamma' : \gamma' \text{ is a half orbit at } p\}$.

We shall define a relation of equivalence on Ω_p by using the complete desingularization of the singular point p in case this point is nilpotent or intricate. There are two ways to desingularize such a singular point: by passing to polar coordinates or by using rational changes of coordinates. The first has the inconvenience of using trigonometrical functions, and this becomes a serious problem when a chain of blow-ups are needed in order to complete the desingularization of the degenerate point. The second uses rational changes of coordinates, convenient for our polynomial systems. In such a case two blow-ups in different directions are needed and information from both must be glued together to obtain the desired portrait.

Here for desingularization we use the second possibility, namely with rational changes of coordinates at each stage of the process. Two rational changes are needed, one for each direction of the blow-up. If at a stage the coordinates are (x, y) and we do a blow-up of a singular point in y -direction, this means that we introduce a new variable z and consider the diffeomorphism of the (x, y) plane for $x \neq 0$ defined by $\phi(x, y) = (x, y, z)$ where $y = xz$. This diffeomorphism transfers our vector field on the subset $x \neq 0$ of the plane (x, y) on the subset $x \neq 0$ of the algebraic surface $y = zx$. It can easily be checked that the projection $(x, xz, z) \mapsto (x, z)$ of this surface on the (x, z) plane is a diffeomorphism. So our vector field on the plane (x, y) for $x \neq 0$ is diffeomorphic to the vector field thus obtained on the (x, z) plane for $x \neq 0$. The singular point (x_0, y_0) which we can assume to be placed at the origin $(0, 0)$, is then replaced by the straight line $x = 0 = y$ in the 3-dimensional space of coordinates x, y, z . This line is also the z -axis of the plane (x, z) and it is called *blow-up line*.

Analogously we can do a blow-up in the x -direction using the change $(x, y) \rightarrow (zy, y)$ which is a diffeomorphism for $y \neq 0$.

The two directional blow-ups can be simplified in just one 1-direction blow-up if we make sure that the direction in which we do a blow-up is not a characteristic direction, so as to be sure that we are not going to lose information doing the blow-up in the chosen direction. This can be easily solved by a simple linear change of coordinates of the type $(x, y) \rightarrow (x + ky, y)$ where k is a constant (usually 1). It seems natural to call this linear change a k -twist as the y -axis gets twisted with some angle depending on k . It is obvious that the phase portrait of the degenerate point which is studied cannot depend on the set of k 's used in the desingularization process.

Since the complete desingularization of a nilpotent or an intricate singular point in general needs more than one blow-up, we have as many blow-up lines as we have blow-ups. As indicated above a blow-up line may be transformed by means of linear changes and through other blow-up's in other straight lines. We will call such straight lines *blow-up lines of higher order*.

We now introduce an equivalent relation on Ω_p . We say that two half orbits $\gamma'_1, \gamma'_2 \in \Omega_p$ are equivalent if and only if (i) for both γ'_1 and γ'_2 we have $\lim_{t \rightarrow -\infty} \Gamma_1(t) = p = \lim_{t \rightarrow -\infty} \Gamma_2(t)$ or $\lim_{t \rightarrow +\infty} \Gamma_1(t) = p = \lim_{t \rightarrow +\infty} \Gamma_2(t)$, and (ii) after the complete desingularization, these orbits lifted to the final stage are

tangent to the same half-line at the same singular point, or end as orbits of a star node on the same half-plane defined by the blown-up line, and (iii) both orbits must remain in the same half-plane in all the successive blow-up's.

We recall that after a complete desingularization all singular points are elemental or semi-elemental. We now single out two types of equivalence classes:

(a) Suppose that an equivalence class $\mathcal{C} \in \Omega_p / \sim$ is such that its half orbits lifted to the last stage in the desingularization process lead to orbits which possess the following properties: *i*) they belong to an elemental two-directions node or to a semi-elemental saddle-node, and *ii*) they are all tangent to the same half-line which lies on the blow-up line.

(b) Suppose that an equivalence class $\mathcal{C} \in \Omega_p / \sim$ is such that (i) its half orbits lifted to the final stage of the desingularization process, are tangent to a blow-up line of higher order, and (ii) its lifted orbits blown-down to the previous stage of the desingularization, form a part of an elliptic sector.

Let Ω'_p / \sim be the set of all equivalence classes which are of type (a) or (b). Then consider the complement $\mathcal{B}_p = (\Omega_p / \sim) - (\Omega'_p / \sim)$ and consider a set of representatives of \mathcal{B}_p . We call *borsec* anyone of these representatives.

Note that the definition of borsec is independent of the choice of the disc D with boundary δ if D is sufficiently small.

We call *geometric local sector* of a singular point p with respect to a neighborhood V , a region in V delimited by two consecutive borsecs.

To illustrate the definitions of borsec and geometric local sector we will discuss the following example given in Figures 5, 6A and 6B.

We have portrayed an intricate singular point p whose desingularization needs a chain of two blow-ups and where all different kinds of elemental singular points and semi-elemental saddle-nodes appear in every possible position with respect of the blow-up line.

We have taken a small enough neighborhood of the point p of boundary δ . We split the boundary δ in different arcs and points which will correspond to the different equivalence classes of orbits. We have enumerated them from 1 to 24. The arcs of δ denoted with \emptyset_1 and \emptyset_2 correspond to hyperbolic sectors which are not considered in the equivalence classes since the orbits do not tend to p . Some of these equivalence classes have a unique orbit which is then a borsec (like 14^* or 4^*). We add an asterisk superscript to denote these equivalence classes. Other equivalence classes are arcs, like 16^- or 12^- , and one representative of each one of them is taken as a borsec. We add a dash superscript to denote these equivalence classes. The remaining equivalence classes, just denoted by their number, are those which do not produce a borsec by the exceptions given in the definition. We have drawn the separatrices (which are always borsecs) with a bold continuous line. We have drawn the borsecs which are not separatrices with bold dashed lines. Other orbits are drawn as thin continuous lines. Finally, the vertical dashed line is the y -direction in which the first blow-up was done.

We describe a little the blow-ups of the phase portrait of the intricate point p given in Figure 5. Its first blow-up is given in Figure 6A. In it we see from the upper part of the figure to its lower part: q_1) an elemental two-directions node with all but two orbits tangent to the blow-up line; q_2) a semi-elemental saddle-node with direction associated to the non-zero eigenvalue being the blow-up line; q_3) another intricate singular point which needs another blow-up portrayed in Figure 6B; q_4)

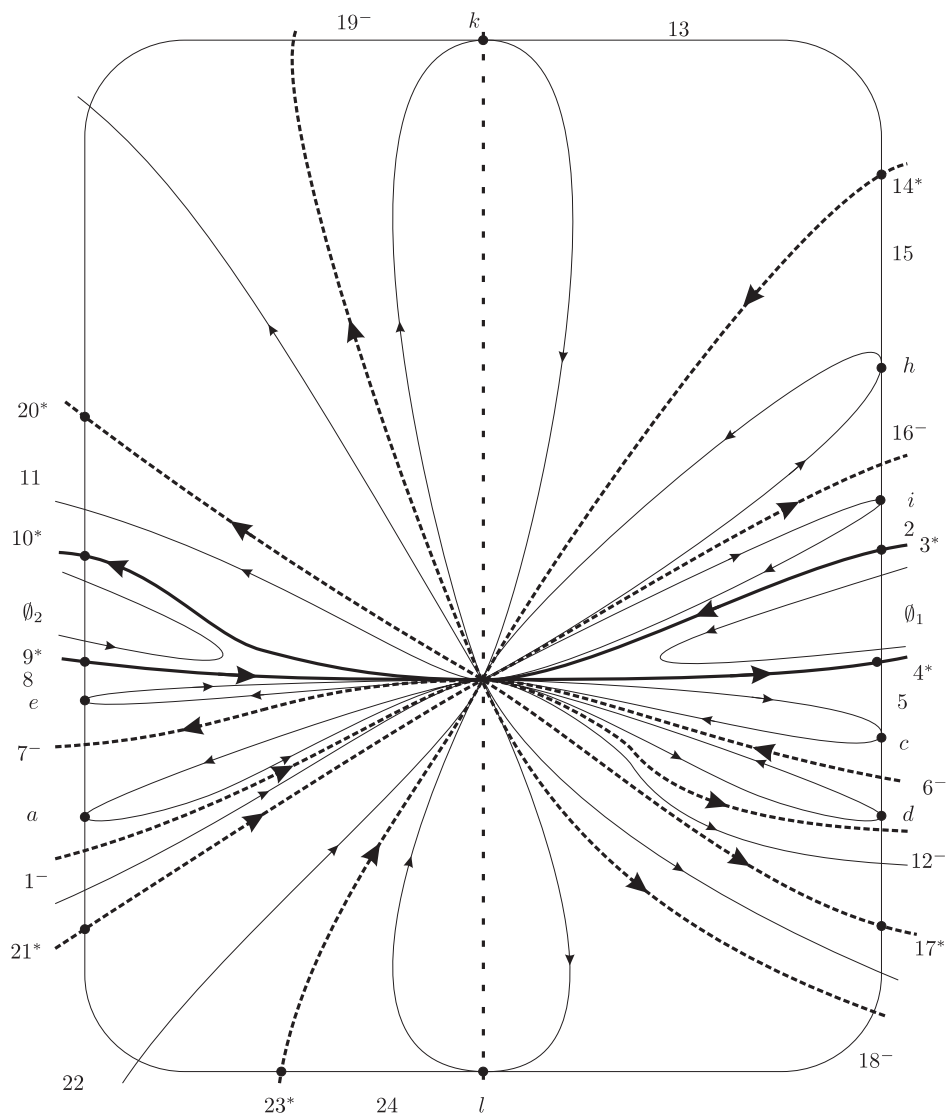

FIGURE 5. Local phase portrait of an intricate singular point.

an elemental saddle; and q_5) an elemental one-direction node which necessarily has its characteristic direction coinciding with the blow-up line.

In order to make the vertical blow-up of the intricate point q_3 we must first do an ε -twist since the vertical direction which corresponds to the previous blow-up line is a characteristic direction of q_3 .

In this second blow-up given in Figure 6B we see going down from its upper part, the following elemental or semi-elemental singular points: r_1) a two-directions node with only two orbits tangent to the blow-up line (this singular point corresponds to the characteristic direction given by the previous blow-up line); r_2) a saddle; r_3) a

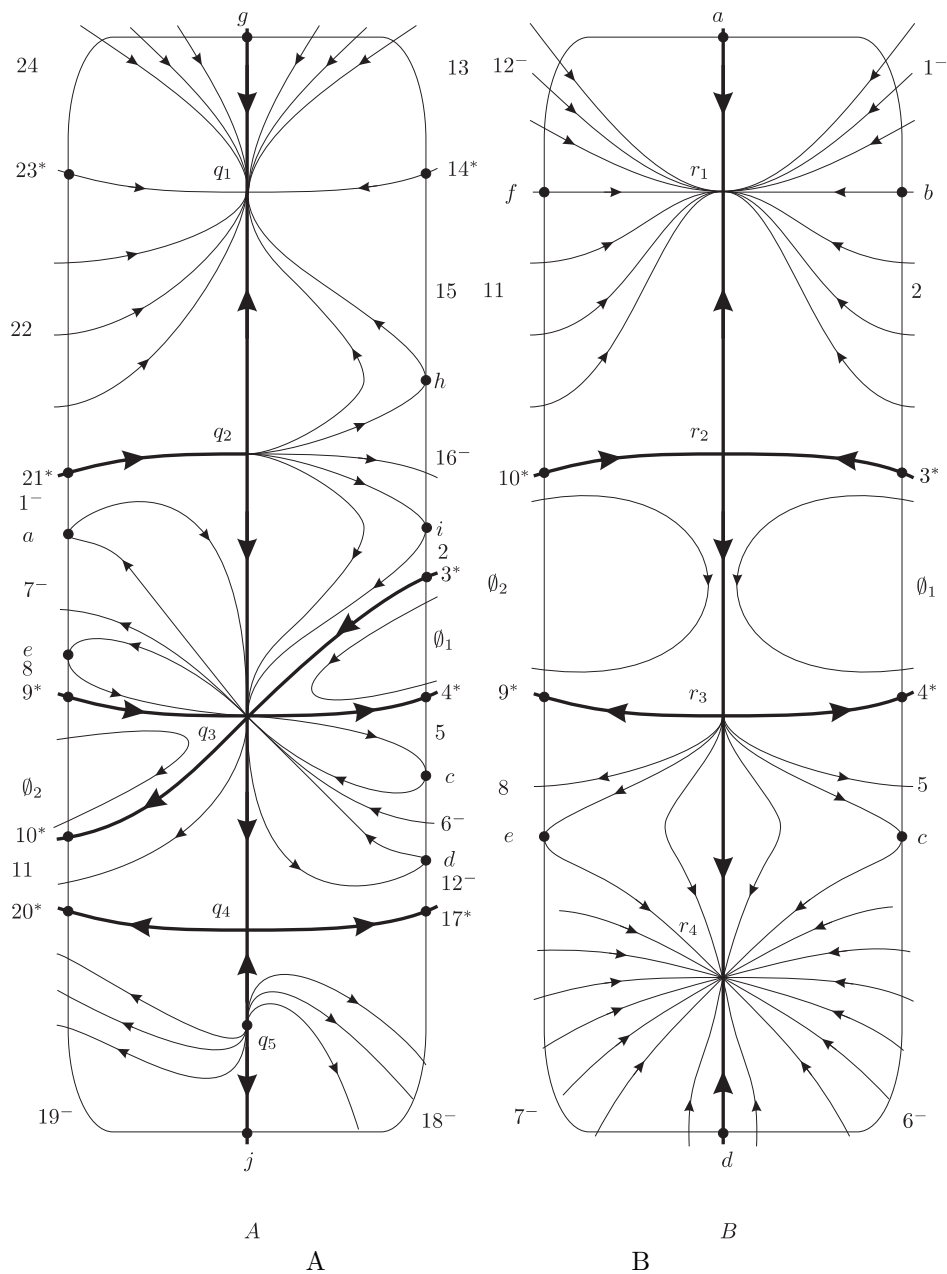

FIGURE 6. The two needed blow-ups for point of Figure 5.

saddle-node with the direction associated to the zero eigenvalue being the blow-up line; r_4) a star node.

Now we describe all the classes of equivalence that we obtain in order to clarify the definitions of borsec and geometric local sector.

We must move from the second blow-up to the first and after that to the original phase portrait. We enumerate the arcs in the boundary of Figure 6B (following the clockwise sense) which will correspond to the classes of equivalence of orbits in Figure 5 as follows.

(1⁻) The arc 1⁻ goes from the point a on the vertical axis to the point b without including any of them.

(2) The arc 2 goes from the point b to the point 3* without including any of them.

The orbit that ends at point b corresponds to the blow-up line in the Figure 6A, and so does not survive in the original phase portrait. Thus the orbits associated to arc 1⁻ cannot belong to the same equivalence class as the orbits associated to arc 2 since in Figure 6A they are in different half-planes defined by the blow-up line.

(3*) The point 3* belongs to the orbit which is a separatrix of the saddle r_2 .

(\emptyset_1) The open arc \emptyset_1 goes between the points 3* and 4* and it is associated to a hyperbolic sector and plays no role.

(4*) The point 4* belongs to the orbit which is a separatrix of the saddle-node r_3 .

(5) The arc 5 goes from the point 4* to the point c including only the second.

(6⁻) The arc 6⁻ goes from the point c to the point d on the vertical axis, including the point c .

The point c belongs to both arcs 5 and 6⁻. In fact it is just a point of partition of the boundary, splitting the orbits that come from r_3 from the orbits that go to r_4 . Since the equivalence classes are defined regarding the half orbits there is no contradiction.

(7⁻) The arc 7⁻ goes from the point d on the vertical axis to the point e including the point e (i.e. $7^- = (d, e]$).

(8) The arc 8 goes from the point e to the point 9* including the point e .

The same comment made for the point c applies to point e .

(9*) The point 9* belongs to the orbit which is a separatrix of the saddle-node r_3 .

(\emptyset_2) The open arc \emptyset_2 between the points 9* and 10* is associated to a hyperbolic sector and plays no role.

(10*) The point 10* belongs to the orbit which is a separatrix of the saddle r_2 .

(11) The arc 11 goes from the point 10* to the point f without including any of them.

(12⁻) The arc 12⁻ goes from the point f to the point a in the vertical axis without including any of them (i.e. $12^- = (d, e)$).

The same comment done for the point b applies to point f .

Now we translate these notations to Figure 6A and complete the notation of the arcs on the boundary of this figure again following the clockwise sense.

(13) The arc 13 goes from the point g on the vertical axis to the point 14* without including any of them.

(14*) The point 14* belongs to the orbit which is tangent to the eigenvector associated to the greatest eigenvalue of the node q_1 .

(15) The arc 15 goes from the point 14* to the point h including only the second.

(16⁻) The arc 16⁻ goes from the point h to the point i including both (i.e. $16^- = [d, e]$).

The following arcs and points from the point i to the point 17^* have already received their names when we did the blow-down from Figure 6B to Figure 6A.

The arcs 6^- and 12^- of Figure 6B become adjacent in Figure 6A and the points a and d are glued together and correspond to the point which after the $-\varepsilon$ -twist goes to the vertical axis. The region defined by these arcs forms now an elliptic sector.

(17 *) The point 17^* belongs to the orbit which is a separatrix of the saddle q_4 .

(18 $^-$) The arc 18^- goes from the point 17^* to the point j without including any of them (i.e. $18^- = (17^*, j)$).

(19 $^-$) The arc 19^- goes from the point j to the point 20^* without including any of them (i.e. $19^- = (j, 20^*)$).

(20 *) The point 20^* belongs to the orbit which is a separatrix of the saddle q_4 .

The following arcs and points from the point 20^* to the point 21^* have already received their names when we have done the blow-down from Figure 6B to Figure 6A.

(21 *) The point 21^* belongs to the orbit which is a separatrix of the saddle-node q_2 .

(22) The arc 22 goes from the point 21^* to the point 23^* without including any of them.

(23 *) The point 23^* belongs to the orbit which is tangent to the eigenvector associated to the greatest eigenvalue of the node q_1 .

(24) The arc 24 goes from the point 23^* to the point g in the vertical axis without including any of them.

Now we move to the original phase portrait in Figure 5. For clarity it is convenient to start the description with a hyperbolic sector.

The orbit associated to the point 4^* defines an equivalent class with a single element and then, this element is a borsec. Moreover it is a global separatrix.

The orbits associated to the points of the arc 5 form a class of equivalence but define no borsec since in the final desingularization (Figure 6B) these orbits end at a saddle-node tangent to the blow-up line and thus these orbits are in a class of equivalence of type (a) which does not produce borsec.

The orbits associated to the points of the arc 6^- form a class of equivalence defining a borsec which splits the two local geometric elliptic sectors that we see in Figure 5. This borsec is not a separatrix.

The orbits associated to the points of the arc 12^- form a class of equivalence defining a borsec which splits a local elliptic sector from a parabolic local sector that we can see in Figure 5. Even though the class 12^- has been split from class 11 by the blow-up line of higher order (the straight line passing through point r_1 and going from point b to point f in Figure 6B), we see that class 12^- corresponds to the part of an elliptic sector with its characteristic direction tangent to the blow-up line. So, this class of equivalence is not of type (b) and we must define a borsec there. The point (b) however will occur later on in our discussion, more precisely when we consider the arc 11.

The orbit associated to the point 17^* defines an equivalent class with a single element and then, this element is a borsec. This borsec is not a separatrix. It is just part of a global parabolic sector but locally distinguishes the three different characteristic directions of the orbits in the arc of δ going from d to l .

The orbits associated to the points of the arc 18^- form a class of equivalence defining a borsec which splits a local elliptic sector from a parabolic one that we can see in Figure 5.

The orbits associated to the points of the arc 24 form a class of equivalence but this does not define a borsec because in the final desingularization, the corresponding orbits end at a two-directions node tangent to the blow-up line (this class of equivalence is of type (a)).

The orbit associated to the point 23^* defines an equivalent class with a single element and then this element is a borsec which splits a local elliptic sector from a parabolic one that we can see in Figure 5.

The orbits associated to the points of the arc 22^- form a class of equivalence but this does not define a borsec because in the final desingularization, the corresponding orbits end at a two-directions node tangent to the blow-up line (this class of equivalence is of type (a)).

The orbit associated to the point 21^* defines an equivalent class with a single element and then, this element is a borsec.

The orbits associated to the points of the arc 1^- form a class of equivalence defining a borsec which splits a local elliptic sector from a parabolic one that we can see in Figure 5. Even though the class 1^- has been split from class 2 by the blow-up line of higher order, in Figure 6B, we see that class 1^- corresponds to a part of an elliptic sector with its characteristic direction tangent to the blow-up line. So, this is not a class of equivalence of type (b) and we must define a borsec here.

The orbits associated to the points of the arc 7^- form a class of equivalence defining a borsec which splits the two local elliptic sectors that we see in Figure 5. As in the case of arc 6^- this borsec is not a separatrix.

The orbits associated to the points of the arc 8 form a class of equivalence but define no borsec since in the final desingularization (Figure 6B) these orbits end at a saddle-node tangent to the blow-up line (this equivalence class is of type (a)).

The orbit associated to the point 9^* defines an equivalent class with a single element and then, this element is a borsec. Moreover it is a global separatrix.

The orbits associated to the open arc \emptyset_2 form a hyperbolic sector and are not associated to any equivalence class since they do not end at the singular point.

The orbit associated to the point 10^* defines an equivalent class with a single element and then, this element is a borsec. Moreover it is a global separatrix.

The orbits associated to the points of the arc 11 form a class of equivalence but define no borsec since class 11 is of type (b). In this case we are in a similar situation as with the arc 12^- but now, since the point r_2 is a saddle, the arc 11 in Figure 6A defines a parabolic sector and so there is no need of a borsec, which would otherwise be needed if the sector were elliptic.

The orbit associated to the point 20^* defines an equivalent class with a single element and then, this element is a borsec. This is similar to the case 17^* .

The orbits associated to the points of the arc 19^- form a class of equivalence defining a borsec which splits a local elliptic sector from a parabolic one that we can see in Figure 5. This is similar to the case 18^- .

The orbits associated to the points of the arc 13 form a class of equivalence but this does not define a borsec analogously with the case 24.

The orbit associated to the point 14^* defines an equivalent class with a single element and then, this element is a borsec.

The orbits associated to the points of the arc 15 form a class of equivalence which does not define a borsec analogously to the case 13 .

The orbits associated to the points of the arc 16^- form a class of equivalence defining a borsec which splits two local elliptic sectors. This is similar to the case 7^- .

The orbits associated to the points of arc 2 form a class of equivalence but define no borsec by the same arguments used for the arc 11 .

The orbit associated to the point 3^* defines an equivalent class with a single element and then, this element is a borsec. Moreover it is a separatrix.

Generically a *geometric local sector* is defined by two borsecs arriving at the singular point with two different well defined angles and which are consecutive. If this sector is parabolic, then the solutions can arrive at the singular point with one of the two characteristic angles, and this is a geometric information than can be revealed with the blow-up.

There is also the possibility that two borsecs defining a geometric local sector tend to the singular point with the same well defined angle. Such a sector will be called a *cusplike sector* which can either be hyperbolic, elliptic or parabolic denoted by H_λ , E_λ and P_λ respectively.

In the case of parabolic sectors we want to include the information as the orbits arrive tangent to one or to the other borsec. We distinguish the two cases writing by \widehat{P} if they arrive tangent to the borsec limiting the previous sector in clockwise sense or \widetilde{P} if they arrive tangent to the borsec limiting the next sector. In the case of a cusplike parabolic sector, all orbits must arrive with only one well determined angle, but the distinction between \widehat{P} and \widetilde{P} is still valid because it occurs at some stage of the desingularization and this can be algebraically determined. Thus complicated intricate singular points like the two we see in Figure 7 may be described as $\widehat{P}E\widehat{P}HHH$ (case (a)) and $E\widetilde{P}_\lambda H\widehat{P}_\lambda E$ (case (b)), respectively.

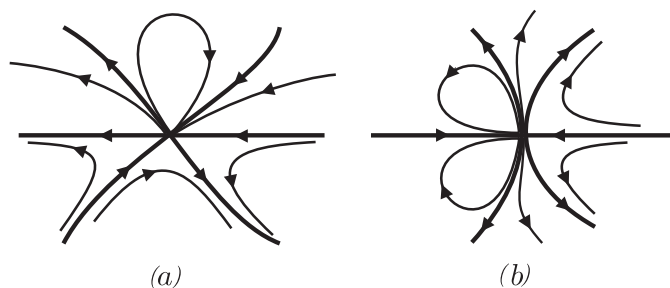

FIGURE 7. Two phase portraits of degenerate singular points.

The phase portrait of the intricate point of Figure 5 could be described as

$$H_\lambda E_\lambda E_\lambda \widehat{P} \widehat{P} E \widehat{P} \widetilde{P} E_\lambda E_\lambda H_\lambda \widehat{P} \widehat{P} E E E$$

starting with the hyperbolic sector \emptyset_1 and going in the clockwise direction.

A star-like point can either be a node or something much more complicated with elliptic and hyperbolic sectors included. In case there are hyperbolic sectors,

they must be cusp-like. Elliptic sectors can either be cusp-like or star-like. We call *special characteristic angle* any well defined angle of a star-like point, in which either none or more than one solution curve tends to p within this well defined angle. We will call *special characteristic direction* any line such that at least one of the two angles defining it, is a special characteristic angle.

4. NOTATION FOR SINGULARITIES OF POLYNOMIAL DIFFERENTIAL SYSTEMS

In [3] we introduced convenient notations which we also used in [4] and which we are also using here. These notations can easily be extended to general polynomial systems.

We describe the finite and infinite singularities, denoting the first ones with lower case letters and the second with capital letters. When describing in a sequence both finite and infinite singular points, we will always place first the finite ones and only later the infinite ones, separating them by a semicolon ‘;’.

Elemental points: We use the letters ‘ s ’, ‘ S ’ for “saddles”; ‘ n ’, ‘ N ’ for “nodes”; ‘ f ’ for “foci”; ‘ c ’ for “centers” and \odot (respectively \odot) for complex finite (respectively infinite) singularities. In order to augment the level of precision we distinguish the finite nodes as follows:

- ‘ n ’ for a node with two distinct eigenvalues (generic node);
- ‘ n^d ’ (a one-direction node) for a node with two identical eigenvalues whose Jacobian matrix is not diagonal;
- ‘ n^* ’ (a star node) for a node with two identical eigenvalues whose Jacobian matrix is diagonal.

In the case of an elemental infinite generic node, we want to distinguish whether the eigenvalue associated to the eigenvector directed towards the affine plane is, in absolute value, greater or lower than the eigenvalue associated to the eigenvector tangent to the line at infinity. This is relevant because this determines if all the orbits except one on the Poincaré disk arrive at infinity tangent to the line at infinity or transversal to this line. We will denote them as ‘ N^∞ ’ and ‘ N^f ’ respectively.

Finite elemental foci and saddles are classified as strong or weak foci, respectively strong or weak saddles. When the trace of the Jacobian matrix evaluated at those singular points is not zero, we call them strong saddles and strong foci and we maintain the standard notations ‘ s ’ and ‘ f ’. But when the trace is zero, except for centers and saddles of infinite order (i.e. with all their Poincaré-Lyapounov constants equal to zero), it is known that the foci and saddles, in the quadratic case, may have up to 3 orders. We denote them by ‘ $s^{(i)}$ ’ and ‘ $f^{(i)}$ ’ where $i = 1, 2, 3$ is the order. In addition we have the centers which we denote by ‘ c ’ and saddles of infinite order (integrable saddles) which we denote by ‘ s ’.

Foci and centers cannot appear as singular points at infinity and hence there is no need to introduce their order in this case. In case of saddles, we can have weak saddles at infinity but the maximum order of weak singularities in cubic systems is not yet known. For this reason, a complete study of weak saddles at infinity cannot be done at this stage. Due to this, in [3] and in [4] and here we chose not even to distinguish between a saddle and a weak saddle at infinity.

All non-elemental singular points are multiple points, in the sense that there are perturbations which have at least two elemental singular points as close as we wish to the multiple point. For finite singular points we denote with a subindex

their multiplicity as in $\overline{s}_{(5)}$ or in $\widehat{e}s_{(3)}$ (the notation $\overline{}$ indicates that the saddle is semi-elemental and $\widehat{}$ indicates that the singular point is nilpotent). In order to describe the various kinds of multiplicity for infinite singular points we use the concepts and notations introduced in [26]. Thus we denote by $\binom{a}{b} \dots$ the maximum number a (respectively b) of finite (respectively infinite) singularities which can be obtained by perturbation of the multiple point. For example $\binom{1}{1}SN$ means a saddle-node at infinity produced by the collision of one finite singularity with an infinite one; $\binom{0}{3}S$ means a saddle produced by the collision of 3 infinite singularities.

Semi-elemental points: They can either be nodes, saddles or saddle-nodes, finite or infinite. We will denote the semi-elemental ones always with an overline, for example \overline{sn} , \overline{s} and \overline{n} with the corresponding multiplicity. In the case of infinite points we will put $\overline{}$ on top of the parenthesis with multiplicities.

Moreover, in cases that will be explained later (see the paragraph dedicated to intricate points), an infinite saddle-node may be denoted by $\binom{1}{1}NS$ instead of $\binom{1}{1}SN$. Semi-elemental nodes could never be n^d or n^* since their eigenvalues are always different. In case of an infinite semi-elemental node, the type of collision determines whether the point is denoted by N^f or by N^∞ where $\binom{2}{1}N$ is an N^f and $\binom{0}{3}N$ is an N^∞ .

Nilpotent points: They can either be saddles, nodes, saddle-nodes, elliptic-saddles, cusps, foci or centers. The first four of these could be at infinity. We denote the nilpotent singular points with a hat $\widehat{}$ as in $\widehat{e}s_{(3)}$ for a finite nilpotent elliptic-saddle of multiplicity 3 and $\widehat{c}p_{(2)}$ for a finite nilpotent cusp point of multiplicity 2. In the case of nilpotent infinite points, we will put the $\widehat{}$ on top of the parenthesis with multiplicity, for example $\widehat{\binom{1}{2}}PEP-H$ (the meaning of $PEP-H$ will be explained in next paragraph). The relative position of the sectors of an infinite nilpotent point, with respect to the line at infinity, can produce topologically different phase portraits. This forces to use a notation for these points similar to the notation which we will use for the intricate points.

Intricate points: It is known that the neighborhood of any singular point of a polynomial vector field (except for foci and centers) is formed by a finite number of sectors which could only be of three types: parabolic, hyperbolic and elliptic (see [14]). Then, a reasonable way to describe intricate and nilpotent points is to use a sequence formed by the types of their sectors. The description we give is the one which appears in the clockwise direction (starting anywhere) once the blow-down of the desingularization is done. Thus in *non-degenerate* quadratic systems (that is, both components of the system are coprime), we have just seven possibilities for finite intricate singular points of multiplicity four (see [5]) which are the following ones: $phpphp_{(4)}$; $phph_{(4)}$; $hh_{(4)}$; $hhhhhh_{(4)}$; $peppep_{(4)}$; $pepe_{(4)}$; $ee_{(4)}$.

The lower case letters used here indicate that we have finite singularities and subindex (4) indicates the multiplicity 4 of the singularities.

For infinite intricate and nilpotent singular points, we insert a dash (hyphen) between the sectors to split those which appear on one side or the other of the equator of the sphere. In this way we will distinguish between $\binom{2}{2}PHP-PPH$ and $\binom{2}{2}PPH-PPH$.

Whenever we have an infinite nilpotent or intricate singular point, we will always start with a sector bordering the infinity (to avoid using two dashes). When one needs to describe a configuration of singular points at infinity, then in some cases the relative positions of the points, is relevant. In [3] this situation only occurs once for systems having two semi-elemental saddle-nodes at infinity and a third singular point which is elemental. In this case we need to write NS instead of SN for one of the semi-elemental points in order to have coherence of the positions of the parabolic (nodal) sector of one point with respect to the hyperbolic (saddle) of the other semi-elemental point. More concretely, the *Config. 3* in Figure 2 must be described as $\overline{\binom{1}{1}}SN, \overline{\binom{1}{1}}SN, N$ since the elemental node lies always between the hyperbolic sectors of one saddle-node and the parabolic ones of the other. However, the *Config. 4* in Figure 2 must be described as $\overline{\binom{1}{1}}SN, \overline{\binom{1}{1}}NS, N$ since the hyperbolic sectors of each saddle-node lie between the elemental node and the parabolic sectors of the other saddle-node. These two configurations have exactly the same description of singular points but their relative position produces topologically (and geometrically) different portraits.

For the description of the topological phase portraits around the isolated singular points of QS the information described above is sufficient. However we are interested in additional geometric features such as the number of characteristic directions which figure in the final global picture of the desingularization. In order to add this information we need to introduce more notation. If two borsecs (the limiting orbits of a sector) arrive at the singular point with the same direction, then the sector will be denoted by H_λ, E_λ or P_λ . The index in this notation refers to the cusp-like form of limiting trajectories of the sectors. Moreover, in the case of parabolic sectors we want to make precise whether the orbits arrive tangent to one borsec or to the other. We distinguish the two cases by \widehat{P} if they arrive tangent to the borsec limiting the previous sector in clockwise sense or \widetilde{P} if they arrive tangent to the borsec limiting the next sector. A parabolic sector will be P^* when all orbits arrive with all possible slopes between the two consecutive borsecs. In the case of a cusp-like parabolic sector, all orbits must arrive with only one direction, but the distinction between \widehat{P} and \widetilde{P} is still valid if we consider the different desingularizations we obtain from them. Thus, complicated intricate singular points like the two we see in Figure 7 may be described as $\binom{4}{2}\widehat{P}E\widetilde{P}-HHH$ (case (a)) and $\binom{4}{3}E\widetilde{P}_\lambda H - H\widehat{P}_\lambda E$ (case (b)), respectively.

Finally there is also the possibility that we have an infinite number of infinite singular points.

Line at infinity filled up with singularities: It is known that any such system has in a sufficiently small neighborhood of infinity one of 6 topological distinct phase portraits (see [29]). The way to determine these portraits is by studying the reduced systems on the infinite local charts after removing the degeneracy of the systems within these charts. In case a singular point still remains on the line at infinity we study such a point. In [29] the tangential behavior of the solution curves was not considered in the case of a node. If after the removal of the degeneracy in the local charts at infinity a node remains, this could either be of the type N^d, N or N^* (this last case does not occur in quadratic systems as it was shown in [3]). Since no eigenvector of such a node N (for quadratic systems) will have the direction of the line at infinity we do not need to distinguish N^f and N^∞ . Other types of

singular points at infinity of quadratic systems, after removal of the degeneracy, can be saddles, centers, semi-elemental saddle-nodes or nilpotent elliptic-saddles. We also have the possibility of no singularities after the removal of the degeneracy. To convey the way these singularities were obtained as well as their nature, we use the notation $[\infty; \emptyset]$, $[\infty; N]$, $[\infty; N^d]$, $[\infty; S]$, $[\infty; C]$, $[\infty; \binom{2}{0}SN]$ or $[\infty; \binom{3}{0}ES]$.

5. INVARIANT POLYNOMIALS AND PRELIMINARY RESULTS

Consider real quadratic systems of the form

$$\begin{aligned}\frac{dx}{dt} &= p_0 + p_1(x, y) + p_2(x, y) \equiv P(x, y), \\ \frac{dy}{dt} &= q_0 + q_1(x, y) + q_2(x, y) \equiv Q(x, y),\end{aligned}\tag{5.1}$$

with homogeneous polynomials p_i and q_i ($i = 0, 1, 2$) of degree i in x, y written as

$$\begin{aligned}p_0 &= a_{00}, & p_1(x, y) &= a_{10}x + a_{01}y, & p_2(x, y) &= a_{20}x^2 + 2a_{11}xy + a_{02}y^2, \\ q_0 &= b_{00}, & q_1(x, y) &= b_{10}x + b_{01}y, & q_2(x, y) &= b_{20}x^2 + 2b_{11}xy + b_{02}y^2.\end{aligned}$$

Let $\tilde{a} = (a_{00}, a_{10}, a_{01}, a_{20}, a_{11}, a_{02}, b_{00}, b_{10}, b_{01}, b_{20}, b_{11}, b_{02})$ be the 12-tuple of the coefficients of systems (5.1) and denote $\mathbb{R}[\tilde{a}, x, y] = \mathbb{R}[a_{00}, \dots, b_{02}, x, y]$.

5.1. Affine invariant polynomials associated with infinite singularities. It is known that on the set QS of all quadratic differential systems (5.1) acts the group $Aff(2, \mathbb{R})$ of affine transformations on the plane (cf. [26]). For every subgroup $G \subseteq Aff(2, \mathbb{R})$ we have an induced action of G on QS. We can identify the set QS of systems (5.1) with a subset of \mathbb{R}^{12} via the map $QS \rightarrow \mathbb{R}^{12}$ which associates to each system (5.1) the 12-tuple (a_{00}, \dots, b_{02}) of its coefficients.

For the definitions of a GL -comitant and invariant as well as for the definitions of a T -comitant and a CT -comitant we refer the reader to the paper [26] (see also [32]). Here we shall only construct the necessary T -comitants and CT -comitants associated to configurations of singularities (including multiplicities) of quadratic systems (5.1). All polynomials constructed here are GL -comitants. But some are also affine invariants or even affine comitants.

Consider the polynomial $\Phi_{\alpha, \beta} = \alpha P^* + \beta Q^* \in \mathbb{R}[\tilde{a}, X, Y, Z, \alpha, \beta]$ where $P^* = Z^2P(X/Z, Y/Z)$, $Q^* = Z^2Q(X/Z, Y/Z)$, $P, Q \in \mathbb{R}[\tilde{a}, x, y]$ and

$$\max(\deg_{(x,y)} P, \deg_{(x,y)} Q) = 2.$$

Then

$$\begin{aligned}\Phi_{\alpha, \beta} &= s_{11}(\tilde{a}, \alpha, \beta)X^2 + 2s_{12}(\tilde{a}, \alpha, \beta)XY + s_{22}(\tilde{a}, \alpha, \beta)Y^2 + 2s_{13}(\tilde{a}, \alpha, \beta)XZ \\ &\quad + 2s_{23}(\tilde{a}, \alpha, \beta)YZ + s_{33}(\tilde{a}, \alpha, \beta)Z^2\end{aligned}$$

and we denote

$$\begin{aligned}\tilde{D}(\tilde{a}, x, y) &= 4 \det \|s_{ij}(\tilde{a}, y, -x)\|_{i,j \in \{1,2,3\}}, \\ \tilde{H}(\tilde{a}, x, y) &= 4 \det \|s_{ij}(\tilde{a}, y, -x)\|_{i,j \in \{1,2\}}.\end{aligned}$$

We consider the polynomials

$$\begin{aligned}C_i(\tilde{a}, x, y) &= yp_i(\tilde{a}, x, y) - xq_i(\tilde{a}, x, y), \\ D_i(\tilde{a}, x, y) &= \frac{\partial}{\partial x}p_i(\tilde{a}, x, y) + \frac{\partial}{\partial y}q_i(\tilde{a}, x, y),\end{aligned}\tag{5.2}$$

in $\mathbb{R}[\tilde{a}, x, y]$ for $i = 0, 1, 2$ and $i = 1, 2$ respectively. The polynomials C_2 and D_2 are trivial T -comitants (trivial because they only depend on the coefficients of the quadratic terms). Using the so-called *transvectant of order k* (see [16], [19]) of two polynomials $f, g \in \mathbb{R}[\tilde{a}, x, y]$

$$(f, g)^{(k)} = \sum_{h=0}^k (-1)^h \binom{k}{h} \frac{\partial^k f}{\partial x^{k-h} \partial y^h} \frac{\partial^k g}{\partial x^h \partial y^{k-h}},$$

we construct the following GL -comitants of the second degree with respect to the coefficients of the initial system

$$\begin{aligned} T_1(\tilde{a}, x, y) &= (C_0, C_1)^{(1)}, & T_2(\tilde{a}, x, y) &= (C_0, C_2)^{(1)}, & T_3(\tilde{a}) &= (C_0, D_2)^{(1)}, \\ T_4(\tilde{a}) &= (C_1, C_1)^{(2)}, & T_5(\tilde{a}, x, y) &= (C_1, C_2)^{(1)}, & T_6(\tilde{a}, x, y) &= (C_1, C_2)^{(2)}, \\ T_7(\tilde{a}, x, y) &= (C_1, D_2)^{(1)}, & T_8(\tilde{a}, x, y) &= (C_2, C_2)^{(2)}, & T_9(\tilde{a}, x, y) &= (C_2, D_2)^{(1)}. \end{aligned} \tag{5.3}$$

Using these GL -comitants as well as the polynomials (5.2) we construct the additional invariant polynomials (see also [26])

$$\begin{aligned} \tilde{M}(\tilde{a}, x, y) &= (C_2, C_2)^{(2)} \equiv 2 \text{Hess}(C_2(\tilde{a}, x, y)); \\ \eta(\tilde{a}) &= (\tilde{M}, \tilde{M})^{(2)}/384 \equiv \text{Discrim}(C_2(\tilde{a}, x, y)); \\ \tilde{K}(\tilde{a}, x, y) &= \text{Jacob}(p_2(\tilde{a}, x, y), q_2(\tilde{a}, x, y)); \\ K_1(\tilde{a}, x, y) &= p_1(\tilde{a}, x, y)q_2(\tilde{a}, x, y) - p_2(\tilde{a}, x, y)q_1(\tilde{a}, x, y); \\ K_2(\tilde{a}, x, y) &= 4(T_2, \tilde{M} - 2\tilde{K})^{(1)} + 3D_1(C_1, \tilde{M} - 2\tilde{K})^{(1)} \\ &\quad - (\tilde{M} - 2\tilde{K})(16T_3 - 3T_4/2 + 3D_1^2); \\ K_3(\tilde{a}, x, y) &= C_2^2(4T_3 + 3T_4) + C_2(3C_0\tilde{K} - 2C_1T_7) + 2K_1(3K_1 - C_1D_2); \\ \tilde{L}(\tilde{a}, x, y) &= 4\tilde{K} + 8\tilde{H} - \tilde{M}; \\ L_1(\tilde{a}, x, y) &= (C_2, \tilde{D})^{(2)}; \\ \tilde{R}(\tilde{a}, x, y) &= \tilde{L} + 8\tilde{K}; \\ \kappa(\tilde{a}) &= (\tilde{M}, \tilde{K})^{(2)}/4; \\ \kappa_1(\tilde{a}) &= (\tilde{M}, C_1)^{(2)}; \\ \tilde{N}(\tilde{a}, x, y) &= \tilde{K}(\tilde{a}, x, y) + \tilde{H}(\tilde{a}, x, y); \\ \theta_2(\tilde{a}) &= (C_1, \tilde{N})^{(2)}/16, & \theta_6(\tilde{a}, x, y) &= C_1T_8 - 2C_2T_6; \\ \theta_5(\tilde{a}) &= 2C_2(T_6, T_7)^{(1)} - (T_5 + 2D_2C_1)(C_1, D_2^2)^{(2)}. \end{aligned}$$

The geometric meaning of the invariant polynomials C_2, \tilde{M} and η is revealed in the next lemma (see [26]).

Lemma 5.1. *The form of the divisor $D_S(C, Z)$ for systems (5.1) is determined by the corresponding conditions indicated in Table 1, where we write $w_1^c + w_2^c + w_3$ if two of the points, i.e. w_1^c, w_2^c , are complex but not real. Moreover, for each form of the divisor $D_S(C, Z)$ given in Table 1 the quadratic systems (5.1) can be brought via a linear transformation to one of the following canonical systems $(S_I) - (S_V)$*

corresponding to the number and multiplicity at infinity of their singularities at infinity.

Case	Form of $D_S(C, Z)$	Necessary and sufficient conditions on the comitants
1	$w_1 + w_2 + w_3$	$\eta > 0$
2	$w_1^c + w_2^c + w_3$	$\eta < 0$
3	$2w_1 + w_2$	$\eta = 0, \widetilde{M} \neq 0$
4	$3w$	$\widetilde{M} = 0, C_2 \neq 0$
5	$D_S(C, Z)$ undefined	$C_2 = 0$

TABLE 1

$$\begin{aligned} \dot{x} &= a + cx + dy + gx^2 + (h-1)xy, \\ \dot{y} &= b + ex + fy + (g-1)xy + hy^2; \end{aligned} \quad (\mathbf{S}_I)$$

$$\begin{aligned} \dot{x} &= a + cx + dy + gx^2 + (h+1)xy, \\ \dot{y} &= b + ex + fy - x^2 + gxy + hy^2; \end{aligned} \quad (\mathbf{S}_{II})$$

$$\begin{aligned} \dot{x} &= a + cx + dy + gx^2 + hxy, \\ \dot{y} &= b + ex + fy + (g-1)xy + hy^2; \end{aligned} \quad (\mathbf{S}_{III})$$

$$\begin{aligned} \dot{x} &= a + cx + dy + gx^2 + hxy, \\ \dot{y} &= b + ex + fy - x^2 + gxy + hy^2, \end{aligned} \quad (\mathbf{S}_{IV})$$

$$\begin{aligned} \dot{x} &= a + cx + dy + x^2, \\ \dot{y} &= b + ex + fy + xy. \end{aligned} \quad (\mathbf{S}_V)$$

5.2. Affine invariant polynomials associated to finite singularities. Consider the differential operator $\mathcal{L} = x \cdot \mathbf{L}_2 - y \cdot \mathbf{L}_1$ acting on $\mathbb{R}[\tilde{a}, x, y]$ constructed in [10], where

$$\begin{aligned} \mathbf{L}_1 &= 2a_{00} \frac{\partial}{\partial a_{10}} + a_{10} \frac{\partial}{\partial a_{20}} + \frac{1}{2} a_{01} \frac{\partial}{\partial a_{11}} + 2b_{00} \frac{\partial}{\partial b_{10}} + b_{10} \frac{\partial}{\partial b_{20}} + \frac{1}{2} b_{01} \frac{\partial}{\partial b_{11}}, \\ \mathbf{L}_2 &= 2a_{00} \frac{\partial}{\partial a_{01}} + a_{01} \frac{\partial}{\partial a_{02}} + \frac{1}{2} a_{10} \frac{\partial}{\partial a_{11}} + 2b_{00} \frac{\partial}{\partial b_{01}} + b_{01} \frac{\partial}{\partial b_{02}} + \frac{1}{2} b_{10} \frac{\partial}{\partial b_{11}}. \end{aligned}$$

Using this operator and the affine invariant $\mu_0 = \text{Resultant}[p_2(\tilde{a}, x, 1), q_2(\tilde{a}, x, 1), x]$ we construct the following polynomials

$$\mu_i(\tilde{a}, x, y) = \frac{1}{i!} \mathcal{L}^{(i)}(\mu_0), \quad i = 1, \dots, 4,$$

where $\mathcal{L}^{(i)}(\mu_0) = \mathcal{L}(\mathcal{L}^{(i-1)}(\mu_0))$ and $\mathcal{L}^{(0)}(\mu_0) = \mu_0$.

These polynomials are in fact comitants of systems (5.1) with respect to the group $GL(2, \mathbb{R})$ (see [10]). Their geometric meaning is revealed in Lemmas 5.2 and 5.3 below.

Lemma 5.2 ([9]). *The total multiplicity of all finite singularities of a quadratic system (5.1) equals k if and only if for every $i \in \{0, 1, \dots, k-1\}$ we have $\mu_i(\tilde{a}, x, y) = 0$ in the ring $\mathbb{R}[x, y]$ and $\mu_k(\tilde{a}, x, y) \neq 0$. Moreover a system (5.1) is degenerate (i.e. $\gcd(P, Q) \neq \text{constant}$) if and only if $\mu_i(\tilde{a}, x, y) = 0$ in $\mathbb{R}[x, y]$ for every $i = 0, 1, 2, 3, 4$.*

Lemma 5.3 ([10]). *The point $M_0(0, 0)$ is a singular point of multiplicity k ($1 \leq k \leq 4$) for a quadratic system (5.1) if and only if for every $i \in \{0, 1, \dots, k-1\}$ we have $\mu_{4-i}(\tilde{a}, x, y) = 0$ in $\mathbb{R}[x, y]$ and $\mu_{4-k}(\tilde{a}, x, y) \neq 0$.*

We denote

$$\sigma(\tilde{a}, x, y) = \frac{\partial P}{\partial x} + \frac{\partial Q}{\partial y} = \sigma_0(\tilde{a}) + \sigma_1(\tilde{a}, x, y) \ (\equiv D_1(\tilde{a}) + D_2(\tilde{a}, x, y)),$$

and observe that the polynomial $\sigma(\tilde{a}, x, y)$ is an affine comitant of systems (5.1). It is known, that if (x_i, y_i) is a singular point of a system (5.1) then for the trace of its respective linear matrix we have $\rho_i = \sigma(x_i, y_i)$.

Applying the differential operators \mathcal{L} and $(*, *)^{(k)}$ (i.e. transvectant of index k) we define the following polynomial function which governs the values of the traces for finite singularities of systems (5.1).

Definition 5.4 ([33]). We call *trace polynomial* $\mathfrak{T}(w)$ over the ring $\mathbb{R}[\tilde{a}]$ the polynomial defined as follows

$$\mathfrak{T}(w) = \sum_{i=0}^4 \frac{1}{(i!)^2} \left(\sigma_1^i, \frac{1}{i!} \mathcal{L}^{(i)}(\mu_0) \right)^{(i)} w^{4-i} = \sum_{i=0}^4 \mathcal{G}_i(\tilde{a}) w^{4-i}, \tag{5.4}$$

where the coefficients $\mathcal{G}_i(\tilde{a}) = \frac{1}{(i!)^2} (\sigma_1^i, \mu_i)^{(i)} \in \mathbb{R}[\tilde{a}]$, $i = 0, 1, 2, 3, 4$ ($\mathcal{G}_0(\tilde{a}) \equiv \mu_0(\tilde{a})$) are *GL*-invariants.

Using the polynomial $\mathfrak{T}(w)$ we could construct the following four affine invariants $\mathcal{T}_4, \mathcal{T}_3, \mathcal{T}_2, \mathcal{T}_1$, which are responsible for the weak singularities:

$$\mathcal{T}_{4-i}(\tilde{a}) = \frac{1}{i!} \frac{d^i \mathfrak{T}}{dw^i} \Big|_{w=\sigma_0} \in \mathbb{R}[\tilde{a}], \quad i = 0, 1, 2, 3 \quad (\mathcal{T}_4 \equiv \mathfrak{T}(\sigma_0)).$$

The geometric meaning of these invariants is revealed by the next lemma (see [33]).

Lemma 5.5. *Consider a non-degenerate system (5.1) and let $\mathbf{a} \in \mathbb{R}^{12}$ be its 12-tuple of coefficients. Denote by ρ_s the trace of the linear part of this system at a finite singular point M_s , $1 \leq s \leq 4$ (real or complex, simple or multiple). Then the following relations hold.*

(i) For $\mu_0(\mathbf{a}) \neq 0$ (total multiplicity 4)

$$\begin{aligned} \mathcal{T}_4(\mathbf{a}) &= \mathcal{G}_0(\mathbf{a})\rho_1\rho_2\rho_3\rho_4, \\ \mathcal{T}_3(\mathbf{a}) &= \mathcal{G}_0(\mathbf{a})(\rho_1\rho_2\rho_3 + \rho_1\rho_2\rho_4 + \rho_1\rho_3\rho_4 + \rho_2\rho_3\rho_4), \\ \mathcal{T}_2(\mathbf{a}) &= \mathcal{G}_0(\mathbf{a})(\rho_1\rho_2 + \rho_1\rho_3 + \rho_1\rho_4 + \rho_2\rho_3 + \rho_2\rho_4 + \rho_3\rho_4), \\ \mathcal{T}_1(\mathbf{a}) &= \mathcal{G}_0(\mathbf{a})(\rho_1 + \rho_2 + \rho_3 + \rho_4). \end{aligned} \tag{5.5}$$

(ii) For $\mu_0(\mathbf{a}) = 0, \mu_1(\mathbf{a}, x, y) \neq 0$ (total multiplicity 3)

$$\begin{aligned} \mathcal{T}_4(\mathbf{a}) &= \mathcal{G}_1(\mathbf{a})\rho_1\rho_2\rho_3, \quad \mathcal{T}_3(\mathbf{a}) = \mathcal{G}_1(\mathbf{a})(\rho_1\rho_2 + \rho_1\rho_3 + \rho_2\rho_3), \\ \mathcal{T}_2(\mathbf{a}) &= \mathcal{G}_1(\mathbf{a})(\rho_1 + \rho_2 + \rho_3), \quad \mathcal{T}_1(\mathbf{a}) = \mathcal{G}_1(\mathbf{a}). \end{aligned} \tag{5.6}$$

(iii) For $\mu_0(\mathbf{a}) = \mu_1(\mathbf{a}, x, y) = 0$, $\mu_2(\mathbf{a}, x, y) \neq 0$ (total multiplicity 2)

$$\begin{aligned} \mathcal{T}_4(\mathbf{a}) &= \mathcal{G}_2(\mathbf{a})\rho_1\rho_2, & \mathcal{T}_3(\mathbf{a}) &= \mathcal{G}_2(\mathbf{a})(\rho_1 + \rho_2), \\ \mathcal{T}_2(\mathbf{a}) &= \mathcal{G}_2(\mathbf{a}), & \mathcal{T}_1(\mathbf{a}) &= 0. \end{aligned} \quad (5.7)$$

(iv) For $\mu_0(\mathbf{a}) = \mu_1(\mathbf{a}, x, y) = \mu_2(\mathbf{a}, x, y) = 0$, $\mu_3(\mathbf{a}, x, y) \neq 0$ (one elemental singularity)

$$\mathcal{T}_4(\mathbf{a}) = \mathcal{G}_3(\mathbf{a})\rho_1, \quad \mathcal{T}_3(\mathbf{a}) = \mathcal{G}_3(\mathbf{a}), \quad \mathcal{T}_2(\mathbf{a}) = \mathcal{T}_1(\mathbf{a}) = 0. \quad (5.8)$$

To calculate the values of invariant polynomials, we define here a family of T -comitants (see [26] for detailed definitions) expressed through C_i ($i = 0, 1, 2$) and D_j ($j = 1, 2$):

$$\begin{aligned} \hat{A} &= (C_1, T_8 - 2T_9 + D_2^2)^{(2)} / 144, \\ \hat{D} &= \left[2C_0(T_8 - 8T_9 - 2D_2^2) + C_1(6T_7 - T_6) - (C_1, T_5)^{(1)} \right. \\ &\quad \left. + 6D_1(C_1D_2 - T_5) - 9D_1^2C_2 \right] / 36, \\ \hat{E} &= [D_1(2T_9 - T_8) - 3(C_1, T_9)^{(1)} - D_2(3T_7 + D_1D_2)] / 72, \\ \hat{F} &= \left[6D_1^2(D_2^2 - 4T_9) + 4D_1D_2(T_6 + 6T_7) + 48C_0(D_2, T_9)^{(1)} - 9D_2^2T_4 + 288D_1\hat{E} \right. \\ &\quad \left. - 24(C_2, \hat{D})^{(2)} + 120(D_2, \hat{D})^{(1)} - 36C_1(D_2, T_7)^{(1)} + 8D_1(D_2, T_5)^{(1)} \right] / 144, \\ \hat{K} &= (T_8 + 4T_9 + 4D_2^2) / 72 \equiv \tilde{K} / 4, \\ \hat{H} &= (8T_9 - T_8 + 2D_2^2) / 72 \equiv -\tilde{H} / 4, \quad \hat{M} = T_8, \\ \hat{B} &= \left\{ 16D_1(D_2, T_8)^{(1)}(3C_1D_1 - 2C_0D_2 + 4T_2) + 32C_0(D_2, T_9)^{(1)}(3D_1D_2 \right. \\ &\quad - 5T_6 + 9T_7) + 2(D_2, T_9)^{(1)}(27C_1T_4 - 18C_1D_1^2 - 32D_1T_2 + 32(C_0, T_5)^{(1)}) \\ &\quad + 6(D_2, T_7)^{(1)}[8C_0(T_8 - 12T_9) - 12C_1(D_1D_2 + T_7) + D_1(26C_2D_1 + 32T_5) \\ &\quad + C_2(9T_4 + 96T_3)] + 6(D_2, T_6)^{(1)}[32C_0T_9 - C_1(12T_7 + 52D_1D_2) - 32C_2D_1^2] \\ &\quad + 48D_2(D_2, T_1)^{(1)}(2D_2^2 - T_8) - 32D_1T_8(D_2, T_2)^{(1)} + 9D_2^2T_4(T_6 - 2T_7) \\ &\quad - 16D_1(C_2, T_8)^{(1)}(D_1^2 + 4T_3) + 12D_1(C_1, T_8)^{(2)}(C_1D_2 - 2C_2D_1) \\ &\quad + 6D_1D_2T_4(T_8 - 7D_2^2 - 42T_9) + 12D_1(C_1, T_8)^{(1)}(T_7 + 2D_1D_2) \\ &\quad + 96D_2^2[D_1(C_1, T_6)^{(1)} + D_2(C_0, T_6)^{(1)}] - 16D_1D_2T_3(2D_2^2 + 3T_8) \\ &\quad \left. - 4D_1^3D_2(D_2^2 + 3T_8 + 6T_9) + 6D_1^2D_2^2(7T_6 + 2T_7) - 252D_1D_2T_4T_9 \right\} / (2^8 3^3). \end{aligned}$$

These polynomials in addition to (5.2) and (5.3) will serve as bricks in constructing affine invariant polynomials for systems (5.1).

The following 42 affine invariants A_1, \dots, A_{42} form the minimal polynomial basis of affine invariants up to degree 12. This fact was proved in [11] by constructing A_1, \dots, A_{42} using the above bricks.

$$A_1 = \hat{A}, \quad A_{22} = \frac{1}{1152} [C_2, \hat{D})^{(1)}, D_2)^{(1)}, D_2)^{(1)}, D_2)^{(1)}],$$

$$\begin{aligned}
A_2 &= (C_2, \widehat{D})^{(3)}/12, & A_{23} &= [\widehat{F}, \widehat{H}]^{(1)}, \widehat{K}^{(2)}/8, \\
A_3 &= [C_2, D_2]^{(1)}, D_2^{(1)}, D_2^{(1)}/48, & A_{24} &= [C_2, \widehat{D}]^{(2)}, \widehat{K}^{(1)}, \widehat{H}^{(2)}/32, \\
A_4 &= (\widehat{H}, \widehat{H})^{(2)}, & A_{25} &= [\widehat{D}, \widehat{D}]^{(2)}, \widehat{E}^{(2)}/16, \\
A_5 &= (\widehat{H}, \widehat{K})^{(2)}/2, & A_{26} &= (\widehat{B}, \widehat{D})^{(3)}/36, \\
A_6 &= (\widehat{E}, \widehat{H})^{(2)}/2, & A_{27} &= [\widehat{B}, D_2]^{(1)}, \widehat{H}^{(2)}/24, \\
A_7 &= [C_2, \widehat{E}]^{(2)}, D_2^{(1)}/8, & A_{28} &= [C_2, \widehat{K}]^{(2)}, \widehat{D}^{(1)}, \widehat{E}^{(2)}/16, \\
A_8 &= [\widehat{D}, \widehat{H}]^{(2)}, D_2^{(1)}/8, & A_{29} &= [\widehat{D}, \widehat{F}]^{(1)}, \widehat{D}^{(3)}/96, \\
A_9 &= [\widehat{D}, D_2]^{(1)}, D_2^{(1)}, D_2^{(1)}/48, & A_{30} &= [C_2, \widehat{D}]^{(2)}, \widehat{D}^{(1)}, \widehat{D}^{(3)}/288, \\
A_{10} &= [\widehat{D}, \widehat{K}]^{(2)}, D_2^{(1)}/8, & A_{31} &= [\widehat{D}, \widehat{D}]^{(2)}, \widehat{K}^{(1)}, \widehat{H}^{(2)}/64, \\
A_{11} &= (\widehat{F}, \widehat{K})^{(2)}/4, & A_{32} &= [\widehat{D}, \widehat{D}]^{(2)}, D_2^{(1)}, \widehat{H}^{(1)}, D_2^{(1)}/64, \\
A_{12} &= (\widehat{F}, \widehat{H})^{(2)}/4, & A_{33} &= [\widehat{D}, D_2]^{(1)}, \widehat{F}^{(1)}, D_2^{(1)}, D_2^{(1)}/128, \\
A_{13} &= [C_2, \widehat{H}]^{(1)}, \widehat{H}^{(2)}, D_2^{(1)}/24, & A_{34} &= [\widehat{D}, \widehat{D}]^{(2)}, D_2^{(1)}, \widehat{K}^{(1)}, D_2^{(1)}/64, \\
A_{14} &= (\widehat{B}, C_2)^{(3)}/36, & A_{35} &= [\widehat{D}, \widehat{D}]^{(2)}, \widehat{E}^{(1)}, D_2^{(1)}, D_2^{(1)}/128, \\
A_{15} &= (\widehat{E}, \widehat{F})^{(2)}/4, & A_{36} &= [\widehat{D}, \widehat{E}]^{(2)}, \widehat{D}^{(1)}, \widehat{H}^{(2)}/16, \\
A_{16} &= [\widehat{E}, D_2]^{(1)}, C_2^{(1)}, \widehat{K}^{(2)}/16, & A_{37} &= [\widehat{D}, \widehat{D}]^{(2)}, \widehat{D}^{(1)}, \widehat{D}^{(3)}/576, \\
A_{17} &= [\widehat{D}, \widehat{D}]^{(2)}, D_2^{(1)}, D_2^{(1)}/64, & A_{38} &= [C_2, \widehat{D}]^{(2)}, \widehat{D}^{(2)}, \widehat{D}^{(1)}, \widehat{H}^{(2)}/64, \\
A_{18} &= [\widehat{D}, \widehat{F}]^{(2)}, D_2^{(1)}/16, & A_{39} &= [\widehat{D}, \widehat{D}]^{(2)}, \widehat{F}^{(1)}, \widehat{H}^{(2)}/64, \\
A_{19} &= [\widehat{D}, \widehat{D}]^{(2)}, \widehat{H}^{(2)}/16, & A_{40} &= [\widehat{D}, \widehat{D}]^{(2)}, \widehat{F}^{(1)}, \widehat{K}^{(2)}/64, \\
A_{20} &= [C_2, \widehat{D}]^{(2)}, \widehat{F}^{(2)}/16, & A_{41} &= [C_2, \widehat{D}]^{(2)}, \widehat{D}^{(2)}, \widehat{F}^{(1)}, D_2^{(1)}/64, \\
A_{21} &= [\widehat{D}, \widehat{D}]^{(2)}, \widehat{K}^{(2)}/16, & A_{42} &= [\widehat{D}, \widehat{F}]^{(2)}, \widehat{F}^{(1)}, D_2^{(1)}/16.
\end{aligned}$$

In the above list, the bracket “[” is used in order to avoid placing the otherwise necessary up to five parentheses “(”.

Using the elements of the minimal polynomial basis given above we construct the affine invariants

$$\begin{aligned}
\mathcal{F}_1(\tilde{a}) &= A_2, \\
\mathcal{F}_2(\tilde{a}) &= -2A_1^2A_3 + 2A_5(5A_8 + 3A_9) + A_3(A_8 - 3A_{10} + 3A_{11} + A_{12}) \\
&\quad - A_4(10A_8 - 3A_9 + 5A_{10} + 5A_{11} + 5A_{12}), \\
\mathcal{F}_3(\tilde{a}) &= -10A_1^2A_3 + 2A_5(A_8 - A_9) - A_4(2A_8 + A_9 + A_{10} + A_{11} + A_{12}) + \\
&\quad + A_3(5A_8 + A_{10} - A_{11} + 5A_{12}), \\
\mathcal{F}_4(\tilde{a}) &= 20A_1^2A_2 - A_2(7A_8 - 4A_9 + A_{10} + A_{11} + 7A_{12}) + A_1(6A_{14} - 22A_{15}) \\
&\quad - 4A_{33} + 4A_{34}, \\
\mathcal{F}(\tilde{a}) &= A_7,
\end{aligned}$$

$$\begin{aligned}\mathcal{B}(\tilde{a}) &= -(3A_8 + 2A_9 + A_{10} + A_{11} + A_{12}), \\ \mathcal{H}(\tilde{a}) &= -(A_4 + 2A_5),\end{aligned}$$

as well as the GL -comitants,

$$\begin{aligned}\mathcal{B}_1(\tilde{a}) &= \left\{ (T_7, D_2)^{(1)} [12D_1T_3 + 2D_1^3 + 9D_1T_4 + 36(T_1, D_2)^{(1)}] - 2D_1(T_6, D_2)^{(1)} \right. \\ &\quad \left. \times [D_1^2 + 12T_3] + D_1^2 [D_1(T_8, C_1)^{(2)} + 6((T_6, C_1)^{(1)}, D_2)^{(1)}] \right\} / 144, \\ \mathcal{B}_2(\tilde{a}) &= \left\{ (T_7, D_2)^{(1)} [8T_3(T_6, D_2)^{(1)} - D_1^2(T_8, C_1)^{(2)} - 4D_1((T_6, C_1)^{(1)}, D_2)^{(1)}] \right. \\ &\quad \left. + [(T_7, D_2)^{(1)}]^2 (8T_3 - 3T_4 + 2D_1^2) \right\} / 384, \\ \mathcal{B}_3(\tilde{a}, x, y) &= -D_1^2(4D_2^2 + T_8 + 4T_9) + 3D_1D_2(T_6 + 4T_7) - 24T_3(D_2^2 - T_9), \\ \mathcal{B}_4(\tilde{a}, x, y) &= D_1(T_5 + 2D_2C_1) - 3C_2(D_1^2 + 2T_3).\end{aligned}$$

We note that the invariant polynomials \mathcal{T}_i , \mathcal{F}_i , \mathcal{B}_i ($i=1,2,3,4$), and \mathcal{B} , \mathcal{F} , \mathcal{H} and σ are responsible for weak singularities of the family of quadratic systems (see [33, Main Theorem]).

Now we need also the invariant polynomials which are responsible for the types of the finite singularities. These were constructed in [5]. Here we need only the following ones (we keep the notation from [5]):

$$\begin{aligned}W_3(\tilde{a}) &= [9A_1^2(36A_{18} - 19A_2^2 + 134A_{17} + 165A_{19}) + 3A_{11}(42A_{18} - 102A_{17} \\ &\quad + 195A_{19}) + 2A_2^2(A_{10} + 3A_{11}) + 102A_3(3A_{30} - 14A_{29}) \\ &\quad - 63A_6(17A_{25} + 30A_{26}) + 3A_{10}(14A_{18} - 118A_{17} + 153A_{19} + 120A_{21}) \\ &\quad + 6A_7(329A_{25} - 108A_{26}) + 3A_8(164A_{18} + 153A_{19} - 442A_{17}) \\ &\quad + 9A_{12}(2A_{20} - 160A_{17} - 2A_{18} - 59A_{19}) + 3A_1(77A_2A_{14} \\ &\quad + 235A_2A_{15} - 54A_{36}) + 18A_{21}(21A_9 - 5A_{11}) + 302A_2A_{34} - 366A_{14}^2 \\ &\quad - 12A_{15}(71A_{14} + 80A_{15})] / 9,\end{aligned}$$

$W_4(\tilde{a})$

$$\begin{aligned}&= [1512A_1^2(A_{30} - 2A_{29}) - 648A_{15}A_{26} + 72A_1A_2(49A_{25} + 39A_{26}) \\ &\quad + 6A_2^2(23A_{21} - 1093A_{19}) - 87A_2^4 + 4A_2^2(61A_{17} + 52A_{18} + 11A_{20}) \\ &\quad - 6A_{37}(352A_3 + 939A_4 - 1578A_5) - 36A_8(396A_{29} + 265A_{30}) \\ &\quad + 72A_{29}(17A_{12} - 38A_9 - 109A_{11}) + 12A_{30}(76A_9 - 189A_{10} - 273A_{11} - 651A_{12}) \\ &\quad - 648A_{14}(23A_{25} + 5A_{26}) - 24A_{18}(3A_{20} + 31A_{17}) + 36A_{19}(63A_{20} + 478A_{21}) \\ &\quad + 18A_{21}(2A_{20} + 137A_{21}) - 4A_{17}(158A_{17} + 30A_{20} + 87A_{21}) \\ &\quad - 18A_{19}(238A_{17} + 669A_{19})] / 81,\end{aligned}$$

$$\begin{aligned}W_7(\tilde{a}) &= 12A_{26}(A_{26} - 2A_{25}) + (2A_{29} - A_{30})(A_2^2 - 20A_{17} - 12A_{18} + 6A_{19} + 6A_{21}) \\ &\quad + 48A_{37}(A_1^2 - A_8 - A_{12}),\end{aligned}$$

$$\begin{aligned}W_8(\tilde{a}) &= 64D_1 [((T_6, C_1)^{(1)}, D_2)^{(1)}]^2 [16(C_0, T_6)^{(1)} - 37(D_2, T_1)^{(1)} + 12D_1T_3] \\ &\quad + 4(108D_1^4 - 3T_4^2 - 128T_3T_4 + 42D_1^2T_4) [((T_6, C_1)^{(1)}, D_2)^{(1)}]^2\end{aligned}$$

$$\begin{aligned}
& + 36D_1((T_6, C_1)^{(1)}, D_2)^{(1)} [4D_1(C_0, T_6)^{(1)} - D_1^2(4T_3 + T_4) + 24T_3^2] \\
& \times (C_1, T_8)^{(2)} + 64[(T_6, C_1)^{(1)}, D_2)^{(1)}]^2 [27T_3^2 + 16((T_6, C_1)^{(1)}, C_0)^{(1)}] \\
& - 54[8D_1^4 + D_1^2T_4 - 8D_1(C_0, T_6)^{(1)} + 8D_1^2T_3 + 8T_3^2]((T_6, C_1)^{(1)}, T_6)^{(1)} \\
& \times (C_1, T_8)^{(2)} + 108D_1T_3[(C_1, T_8)^{(2)}]^2 [D_1T_3 - 2(C_0, T_6)^{(1)}] \\
& + 576((T_6, C_1)^{(1)}, D_2)^{(1)} ((T_6, C_1)^{(1)}, T_6)^{(1)} [2(D_2, T_1)^{(1)} - 5D_1T_3] \\
& - 27[(C_1, T_8)^{(2)}]^2 [T_4^4/8 + (C_0, T_1)^{(1)}],
\end{aligned}$$

$$W_9(\tilde{a}) = -3T_4(T_4 + 4D_1^2) - 32D_1(C_0, T_6)^{(1)} - 32((T_6, C_1)^{(1)}, C_0)^{(1)},$$

$$W_{11}(\tilde{a}, x, y) = 2\tilde{K}(C_2, \tilde{D})^{(2)} + 12\tilde{F}(2\tilde{H} + \tilde{K}) - D_2(\tilde{D}, \tilde{K})^{(1)},$$

$$F_4(\tilde{a}, x, y) = \mu_3(\tilde{a}, x, y), \quad F_5(\tilde{a}, x, y) = T_5 + 2C_1D_2 - 3C_2D_1,$$

$$G_3(\tilde{a}) = A_2, \quad \mathbf{D}(\tilde{a}) = [3((\mu_3, \mu_3)^{(2)}, \mu_2)^{(2)} - (6\mu_0\mu_4 - 3\mu_1\mu_3 + \mu_2^2, \mu_4)^{(4)}]/48,$$

$$G_8(\tilde{a}) = (5A_8 - 18A_1^2 - A_{10} - 3A_{11} + 9A_{12})/2, \quad \mathbf{U}(\tilde{a}, x, y) = \mu_3^2 - 4\mu_2\mu_4.$$

Finally we need the invariant polynomials which are responsible for the existence of one (or two) star node(s) arbitrarily located on the phase plane of a system (5.1). We have the following lemma (see [36]).

Lemma 5.6. *A quadratic system (5.1) possesses one star node if and only if one of the following set of conditions holds:*

- (i) $U_1 \neq 0, U_2 \neq 0, U_3 = Y_1 = 0;$
- (ii) $U_1 = U_4 = U_5 = U_6 = 0, Y_2 \neq 0;$

and it possesses two star nodes if and only if

- (iii) $U_1 = U_4 = U_5 = 0, U_6 \neq 0, Y_2 > 0,$ where

$$U_1(\tilde{a}, x, y) = \tilde{N}, \quad U_2(\tilde{a}, x, y) = (C_1, \tilde{H} - \tilde{K})^{(1)} - 2D_1\tilde{N},$$

$$U_3(\tilde{a}, x, y) = 3\tilde{D}(D_2^2 - 16\tilde{K}) + C_2[(C_2, \tilde{D})^{(2)} - 5(D_2, \tilde{D})^{(1)} + 6\tilde{F}],$$

$$U_4(\tilde{a}, x, y) = 2T_5 + C_1D_2, \quad U_5(\tilde{a}, x, y) = 3C_1D_1 + 4T_2 - 2C_0D_1,$$

$$U_6(\tilde{a}, x, y) = \tilde{H}, \quad Y_1(\tilde{a}) = A_1, \quad Y_2(\tilde{a}, x, y) = 2D_1^2 + 8T_3 - T_4.$$

We base our work here on the results obtained in [3, 5, 33].

6. PROOF OF THE MAIN THEOREM

According to [33] for the quadratic systems having the finite singularities of total multiplicity 2 the conditions $\mu_0 = \mu_1 = 0$ and $\mu_2 \neq 0$ must be satisfied. So by [3] the following lemma is valid.

Lemma 6.1. *The configurations of singularities at infinity of the family of quadratic systems possessing finite singularities (real or complex) of total multiplicity 2 (i.e. $\mu_0 = \mu_1 = 0$ and $\mu_2 \neq 0$) are classified in Diagram 4 according to the geometric equivalence relation. Necessary and sufficient conditions for each one of the 43 different equivalence classes can be assembled from these diagrams in terms of 14 invariant polynomials with respect to the action of the affine group and time rescaling, given in Section 5.*

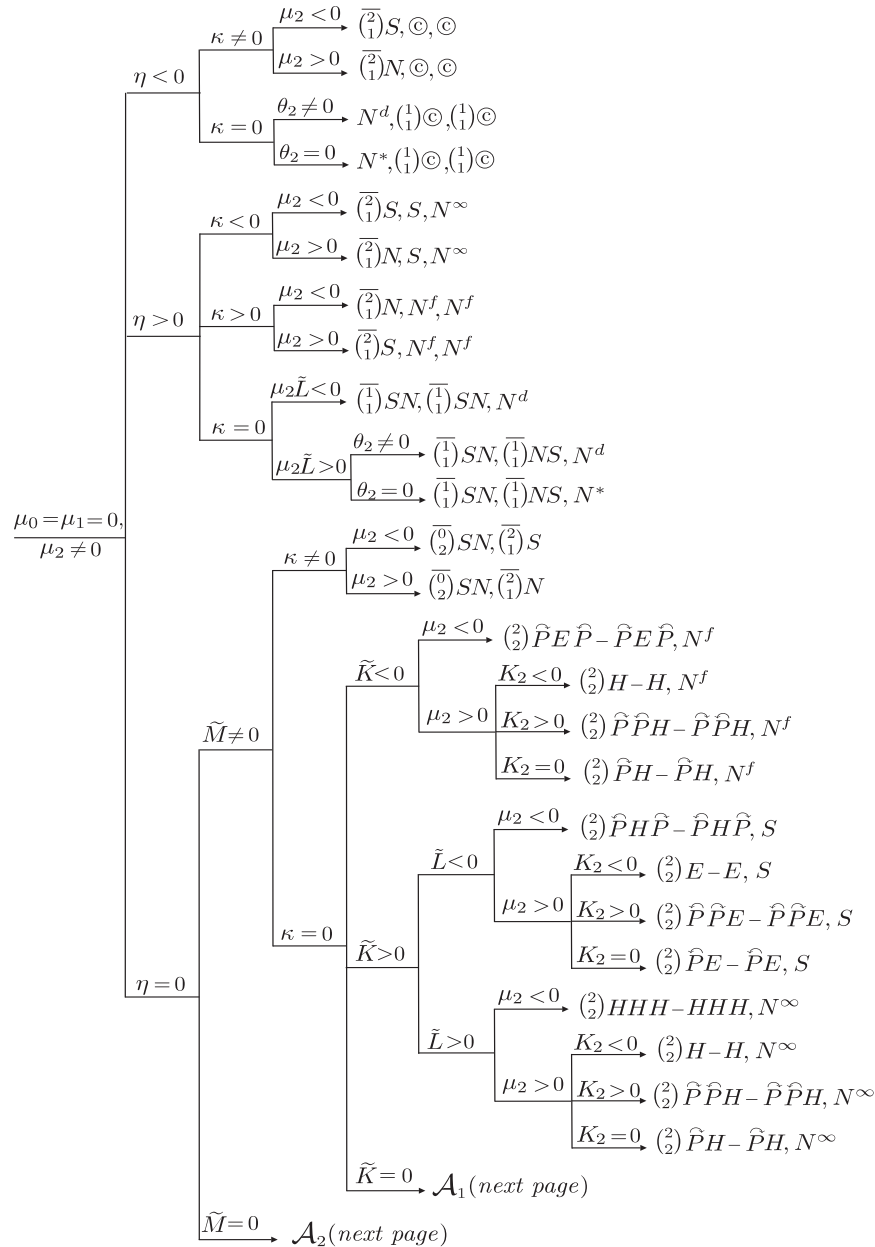

DIAGRAM 4. The case $\mu_0 = \mu_1 = 0, \mu_2 \neq 0$.

6.1. **The family of quadratic differential systems with only two distinct complex finite singularities.** Assuming that quadratic systems (5.1) possess two finite complex singular points, according to [33] (see Table 2) we have to consider two cases: $\tilde{K} \neq 0$ and $\tilde{K} = 0$.

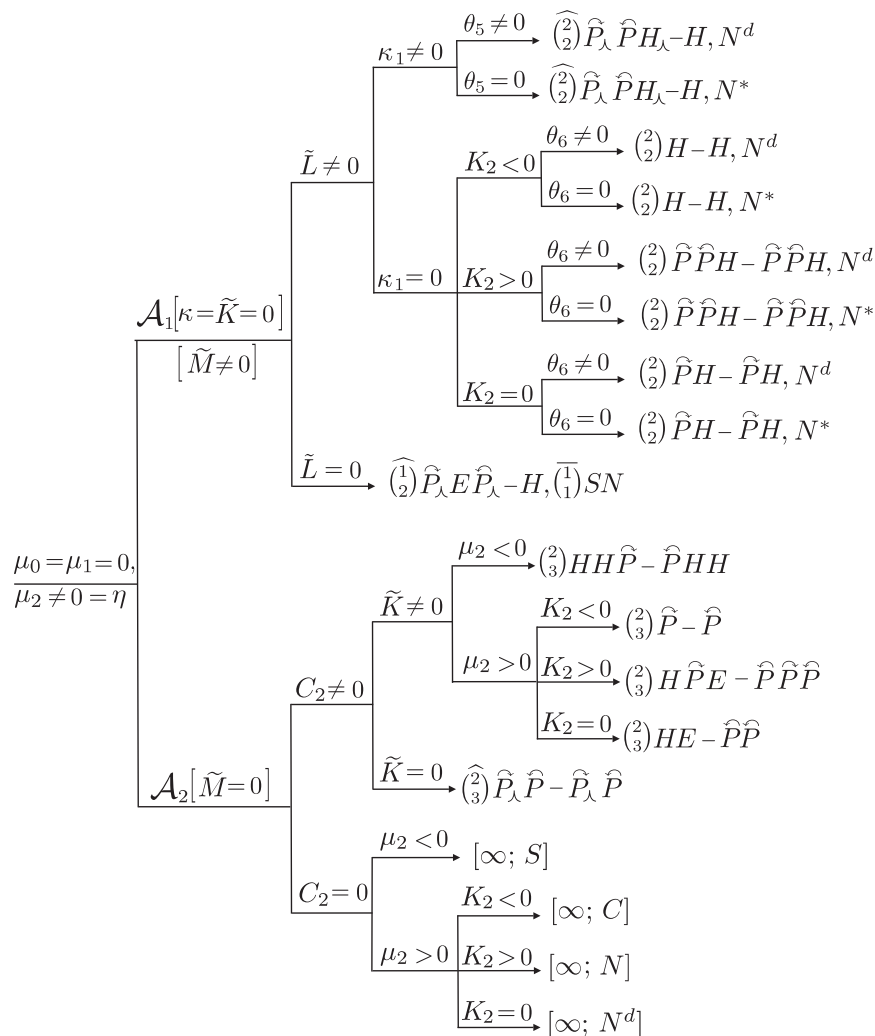

DIAGRAM 4 (continued). The case $\mu_0 = \mu_1 = 0, \mu_2 \neq 0$.

6.1.1. *Systems with $\tilde{K} \neq 0$.* In this case according to [33] we shall consider the following family of systems

$$\dot{x} = a + hux + 2hxy + ay^2, \quad \dot{y} = b + mux + 2mxy + by^2, \tag{6.1}$$

possessing the singular points $M_{1,2}(0, \pm i)$. For these systems calculations yield

$$\begin{aligned} \mu_0 = \mu_1 = 0, \quad \mu_2 &= (bh - am)^2(4 + u^2)y^2, \quad \tilde{K} = 4(bh - am)y^2, \\ \kappa &= -128m^2(bh - am), \quad \eta = 4m^2[(b + 2h)^2 - 8(bh - am)], \\ \tilde{M} &= -32m^2x^2 - 16(b - 2h)mxy - 8[(b - 2h)^2 + 6am]y^2. \end{aligned} \tag{6.2}$$

Remark 6.2. We observe that $\mu_2 > 0$ and if $\kappa \neq 0$ then $\tilde{M} \neq 0$. Moreover the condition $\kappa > 0$ implies $\eta > 0$.

Remark 6.3. The family of systems (6.1) depends on five parameters. However due to a rescaling we can reduce the number of the parameters to three. More precisely since by the condition $\tilde{K} \neq 0$ (i.e. $bh - am \neq 0$) we have $m^2 + h^2 \neq 0$, then we may assume $(m, h) \in \{(1, 1), (1, 0), (0, 1)\}$ due to the rescaling: (i) $(x, y, t) \mapsto (hx/m, y, t/h)$ if $mh \neq 0$; (ii) $(x, y, t) \mapsto (x/m, y, t)$ if $h = 0$, and (iii) $(x, y, t) \mapsto (x, y, t/h)$ if $m = 0$.

Considering (6.2) and $\tilde{K} \neq 0$ we deduce that the condition $m \neq 0$ is equivalent to $\kappa \neq 0$.

The case $\kappa \neq 0$. Then considering Remark 6.3 we shall examine the subfamilies of systems (6.1) with $(m, h) = (1, 1)$ and $(m, h) = (1, 0)$.

A. Systems with $m = h = 1$. We consider the 3-parameter family of systems

$$\dot{x} = a + ux + 2xy + ay^2, \quad \dot{y} = b + ux + 2xy + by^2, \quad (6.3)$$

for which calculations yield

$$\begin{aligned} \mu_0 = \mu_1 = 0, \quad \mu_2 = (a - b)^2(4 + u^2)y^2, \quad \tilde{K} = 4(b - a)y^2, \\ \kappa = 128(a - b), \\ \eta = 4[(b - 2)^2 + 8a], \quad \theta = 64(b - a). \end{aligned} \quad (6.4)$$

The subcase $\kappa < 0$. Since $\mu_2 > 0$ and $\tilde{M} \neq 0$ (see Remark 6.2) according to Lemma 6.1 we get the following three global configurations of singularities:

$$\begin{aligned} \textcircled{\circ}, \textcircled{\circ}; \overline{\begin{pmatrix} 2 \\ 1 \end{pmatrix}} N, \textcircled{\circ}, \textcircled{\circ} : \text{Example} \Rightarrow (a = -1, b = 0, u = 0) \quad (\text{if } \eta < 0); \\ \textcircled{\circ}, \textcircled{\circ}; \overline{\begin{pmatrix} 2 \\ 1 \end{pmatrix}} N, S, N^\infty : \text{Example} \Rightarrow (a = 0, b = 1, u = 0) \quad (\text{if } \eta > 0); \\ \textcircled{\circ}, \textcircled{\circ}; \overline{\begin{pmatrix} 0 \\ 2 \end{pmatrix}} SN, \overline{\begin{pmatrix} 2 \\ 1 \end{pmatrix}} N : \text{Example} \Rightarrow (a = 0, b = 2, u = 0) \quad (\text{if } \eta = 0). \end{aligned}$$

The subcase $\kappa > 0$. By Remark 6.2 we have $\eta > 0$ and considering Lemma 6.1 we arrive at the global configuration of singularities

$$\textcircled{\circ}, \textcircled{\circ}; \overline{\begin{pmatrix} 2 \\ 1 \end{pmatrix}} S, N^f, N^f : \text{Example} \Rightarrow (a = 1, b = 0, u = 0).$$

B. Systems with $m = 1, h = 0$. We consider the 3-parameter family of systems

$$\dot{x} = a + ay^2, \quad \dot{y} = b + ux + 2xy + by^2, \quad (6.5)$$

where we may assume $b \in \{0, 1\}$ due to the rescaling $(x, y, t) \mapsto (bx, y, t/b)$ (if $b \neq 0$). For these systems calculations yield

$$\mu_0 = \mu_1 = 0, \quad \mu_2 = a^2(4 + u^2)y^2, \quad \tilde{K} = -4ay^2, \quad \kappa = 128a, \quad \eta = 4(8a + b^2). \quad (6.6)$$

Considering Remark 6.2 we conclude that the above systems could not possess new configurations different from the configurations of systems (6.3).

The case $\kappa = 0$. Considering (6.2), due to $\tilde{K} \neq 0$ we obtain $m = 0$ and then by Remark 6.3 we may assume $h = 1$. Thus we arrive at the following systems

$$\dot{x} = a + ux + 2xy + ay^2, \quad \dot{y} = b + by^2, \tag{6.7}$$

where due to the rescaling $(x, y, t) \mapsto (ax, y, t)$ (if $a \neq 0$) we can assume $a \in \{0, 1\}$.

For these systems we calculate

$$\begin{aligned} \mu_0 = \mu_1 = \kappa = \kappa_1 = 0, \quad \mu_2 = b^2(4 + u^2)y^2, \quad \tilde{K} = 4by^2, \\ \tilde{L} = 8b(b - 2)y^2, \quad K_2 = -384b^2(4 - 3b + b^2)y^2, \\ \eta = 0, \quad \tilde{M} = -8(b - 2)^2y^2, \quad C_2 = (2 - b)xy^2 + ay^3. \end{aligned} \tag{6.8}$$

The subcase $\tilde{K} < 0$. Then $b < 0$ and this implies $\tilde{M} \neq 0$. We observe that $K_2 < 0$, $\mu_2 > 0$ and considering Lemma 6.1 we obtain the configuration

$$\odot, \odot; \binom{2}{2} H - H, N^f : \text{Example} \Rightarrow (a = 0, b = -2, u = 0).$$

The subcase $\tilde{K} > 0$. We consider two possibilities: $\tilde{L} \neq 0$ and $\tilde{L} = 0$.

(1) The possibility $\tilde{L} \neq 0$. In this case $\tilde{M} \neq 0$ and taking into account the conditions $K_2 < 0$ and $\mu_2 > 0$ by Lemma 6.1 we arrive at the following two global configurations of singularities

$$\begin{aligned} \odot, \odot; \binom{2}{2} E - E, S : \text{Example} \Rightarrow (a = 0, b = 1, u = 0) \quad (\text{if } \tilde{L} < 0); \\ \odot, \odot; \binom{2}{2} H - H, N^\infty : \text{Example} \Rightarrow (a = 0, b = 3, u = 0) \quad (\text{if } \tilde{L} > 0). \end{aligned}$$

(2) The possibility $\tilde{L} = 0$. Since $b \neq 0$ (due to $\mu_2 \neq 0$) we have $b = 2$ and then $\tilde{M} = 0$ and $C_2 = ay^3$. So considering Lemma 6.1 we obtain the following two configurations

$$\begin{aligned} \odot, \odot; \binom{2}{3} \tilde{P} - \tilde{P} : \text{Example} \Rightarrow (a = 1, b = 2, u = 0) \quad (\text{if } C_2 \neq 0); \\ \odot, \odot; [\infty; C] : \text{Example} \Rightarrow (a = 0, b = 2, u = 0) \quad (\text{if } C_2 = 0). \end{aligned}$$

6.1.2. Systems with $\tilde{K} = 0$. In this case according to [33] we consider the following family of systems

$$\dot{x} = a + cx + gx^2 + 2hxy + ay^2, \quad \dot{y} = x, \quad (a \neq 0) \tag{6.9}$$

for which we calculate

$$\begin{aligned} \mu_0 = \mu_1 = \kappa = 0, \quad \mu_2 = a(gx^2 + 2hxy + ay^2)x^2, \quad \tilde{K} = 0, \\ \tilde{L} = 8g(gx^2 + 2hxy + ay^2), \quad \eta = 4g^2(h^2 - ag), \\ \theta_2 = h^2 - ag, \quad \tilde{M} = -8g^2x^2 - 16ghxy + 8(3ag - 4h^2)y^2. \end{aligned} \tag{6.10}$$

As $\mu_2 \neq 0$ we have $\text{sign}(\mu_2\tilde{L}) = \text{sign}(ag)$.

The case $\eta < 0$. Then $\theta_2 \neq 0$ and considering Lemma 6.1 we arrive at the configuration

$$\odot, \odot; N^d, \binom{1}{1} \odot, \binom{1}{1} \odot : \text{Example} \Rightarrow (a = 2, c = 0, g = 1, h = 1).$$

The case $\eta > 0$. As $\theta_2 \neq 0$ considering Lemma 6.1 we obtain the following two global configurations of singularities

$$\textcircled{\textcircled{\circ}}; \overline{\begin{pmatrix} 1 \\ 1 \end{pmatrix}} SN, \overline{\begin{pmatrix} 1 \\ 1 \end{pmatrix}} SN, N^d : \text{Example} \Rightarrow (a = 1, c = 0, g = -1, h = 1) \\ (\text{if } \mu_2 \tilde{L} < 0);$$

$$\textcircled{\textcircled{\circ}}; \overline{\begin{pmatrix} 1 \\ 1 \end{pmatrix}} SN, \overline{\begin{pmatrix} 1 \\ 1 \end{pmatrix}} NS, N^d : \text{Example} \Rightarrow (a = 1, c = 0, g = 1/2, h = 1) \\ (\text{if } \mu_2 \tilde{L} > 0).$$

The case $\eta = 0$.

The subcase $\tilde{L} \neq 0$. Then $g \neq 0$ and we obtain $h^2 - ag = 0$ and as $a \neq 0$ we get $g = h^2/a$. Calculations yield

$$\tilde{L} = 8h^2(hx + ay)^2/a^2, \quad \widetilde{M} = -8h^2(hx + ay)^2/a^2, \\ \kappa_1 = 32h^2(a + ch)/a, \quad \theta_5 = -96h(a + ch)(hx + ay)^3/a^2.$$

As we observe the condition $\tilde{L} \neq 0$ implies $\widetilde{M} \neq 0$, i.e. at infinity we have two distinct singularities.

(1) The possibility $\kappa_1 \neq 0$. Then $\theta_5 \neq 0$ and considering Lemma 6.1 we obtain the configuration

$$\textcircled{\textcircled{\circ}}; \widehat{\begin{pmatrix} 2 \\ 2 \end{pmatrix}} \widehat{P}_\lambda \widehat{P} H_\lambda - H, N^d : \text{Example} \Rightarrow (a = 1, c = 0, g = 1, h = 1).$$

(2) The possibility $\kappa_1 = 0$. As $\tilde{L} \neq 0$ we get $a = -ch \neq 0$ and then we have

$$K_2 = -384h^4(x - cy)^2/c^2, \quad \theta_6 = 8h^2(x - cy)^4/c^2, \quad \mu_2 = h^2x^2(x - cy)^2 \neq 0.$$

So we obtain $K_2 < 0$, $\theta_6 \neq 0$ and considering Lemma 6.1 we obtain the configuration of singularities

$$\textcircled{\textcircled{\circ}}; \widehat{\begin{pmatrix} 2 \\ 2 \end{pmatrix}} H - H, N^d : \text{Example} \Rightarrow (a = -1, c = 1, g = -1, h = 1).$$

The subcase $\tilde{L} = 0$. In this case considering (6.10) we get $g = 0$ and then we calculate

$$\eta = \tilde{L} = 0, \quad \widetilde{M} = -32h^2y^2, \quad C_2 = y^2(2hx + ay), \\ \kappa_1 = 128h^2, \quad \mu_2 = ay(2hx + ay) \neq 0.$$

We observe that the condition $\mu_2 \neq 0$ implies $C_2 \neq 0$. Therefore since $\tilde{L} = 0$ according to Lemma 6.1 we obtain the following two configurations

$$\textcircled{\textcircled{\circ}}; \widehat{\begin{pmatrix} 1 \\ 2 \end{pmatrix}} \widehat{P}_\lambda E \widehat{P}_\lambda - H, \overline{\begin{pmatrix} 1 \\ 1 \end{pmatrix}} SN : \text{Example} \Rightarrow (a = 1, c = 0, g = 0, h = 1) \\ (\text{if } \widetilde{M} \neq 0);$$

$$\textcircled{\textcircled{\circ}}; \widehat{\begin{pmatrix} 2 \\ 3 \end{pmatrix}} \widehat{P}_\lambda \widehat{P} - \widehat{P}_\lambda \widehat{P} : \text{Example} \Rightarrow (a = 1, c = 0, g = 0, h = 0) \quad (\text{if } \widetilde{M} = 0).$$

As all possible cases are examined, we have proved that the family of systems with two complex distinct finite singularities possesses exactly 16 geometrically distinct global configurations of singularities.

6.2. The family of quadratic differential systems with two real distinct finite singularities which in additional are elemental. Assume that quadratic systems (5.1) possess two real finite singular points and both are elemental, i.e. by [33] the conditions $\mu_0 = \mu_1 = 0$, $\mu_2 \neq 0$ and $U > 0$ hold. According to [33] (see Table 2) we have to consider two cases: $\tilde{K} \neq 0$ and $\tilde{K} = 0$.

6.2.1. *Systems with $\tilde{K} \neq 0$.* In this case according to [33] we consider the family of systems

$$\dot{x} = cx + dy - cx^2 + 2duxy, \quad \dot{y} = ex + fy - ex^2 + 2fuxy, \quad (6.11)$$

which possess the singular points $M_1(0, 0)$ and $M_2(1, 0)$.

Remark 6.4. Assume that we have a family of quadratic systems possessing a real elemental singular point for all values of the parameters. Then by a translation of axes we may suppose this point to be placed at the origin. In case we have one other real elemental singularity (or even two such singularities), then we can always use a linear transformation to place the second singularity or even two such singularities in specific positions (for example at $(1, 0)$ and in case a second such singular point exists to place it at $(0, 1)$). We arrive thus at a certain normal form for the family, dictated by the position of these singularities. Suppose that in the course of the study of this family, under certain conditions on parameters expressed in invariant form i.e. in terms of invariant polynomials, we find that an elemental real singularity of the systems has a certain geometric property, for example it is a node. Then we may always suppose this singularity to be placed at the origin. This is clear if we have just one real elemental singularity. If we have other real elemental singular points then by the argument above we can exchange its position with one of the other elemental singular points via an affine transformation without changing the aspect of the normal form.

For systems (6.11) calculations yield

$$\begin{aligned} \mu_0 = \mu_1 = 0, \quad \mu_2 &= (cf - de)^2(1 + 2u)x^2, \\ \tilde{K} &= 4(de - cf)ux^2, \quad \kappa = 128d^2(cf - de)u^3. \end{aligned} \quad (6.12)$$

We remark that for the above systems the condition $\mu_2\tilde{K} \neq 0$ holds. So in what follows we assume that the following condition is satisfied

$$(cf - de)(1 + 2u)u \neq 0. \quad (6.13)$$

Remark 6.5. We observe that the family of systems (6.11) depends on five parameters. However due to a rescaling we can reduce the number of the parameters to three. More precisely since according to condition (6.13) we have $d^2 + f^2 \neq 0$, then we may assume $(d, f) \in \{(1, 1), (1, 0), (0, 1)\}$ due to the rescaling:

- (i) $(x, y, t) \mapsto (x, fy/d, t/f)$ if $df \neq 0$;
- (ii) $(x, y, t) \mapsto (x, y/d, t)$ if $f = 0$, and
- (iii) $(x, y, t) \mapsto (x, y, t/f)$ if $d = 0$.

Considering (6.12) and (6.13) the condition $d \neq 0$ is equivalent to $\kappa \neq 0$.

The case $\kappa \neq 0$. Then considering Remark 6.5 we examine the subfamilies of systems (6.11) with $(d, f) = (1, 1)$ and $(d, f) = (1, 0)$.

A. *Systems with $d = f = 1$.* We consider the 3-parameter family of systems:

$$\begin{aligned} \dot{x} &= cx + y - cx^2 + 2uxy, & (c - e)(1 + 2u)u &\neq 0, \\ \dot{y} &= ex + y - ex^2 + 2uxy, \end{aligned} \quad (6.14)$$

for which calculations yield

$$\begin{aligned} \mu_0 = \mu_1 &= 0, & \mu_2 &= (c - e)^2(1 + 2u)x^2, & \tilde{K} &= 4(e - c)ux^2, \\ \kappa &= 128(c - e)u^3, & \eta &= 4u^2[(c - 2u)^2 + 8(c - e)u], \\ F_2 &= (c - e)^2(1 + 2u)x^2, & G_8 &= 2(c - e)^2u^2(1 + 2u), \\ W_4 &= 16(c - e)^4u^4(1 + 2u)^2[(c - 1)^2 + 4e][(1 - c + 2u)^2 + 4(c - e)(1 + 2u)], \\ W_3 &= 32(c - e)^4u^4(1 + 2u)^2(1 + c^2 + 2u + 2cu - 4eu + 2u^2), \\ \tilde{M} &= -8[(c + 2u)^2 - 6eu]x^2 + 16u(c + 2u)xy - 32u^2y^2, \\ \mathcal{T}_4 &= 4(1 + c)(c - e)^2(1 - c + 2u)u^2(1 + 2u). \end{aligned} \quad (6.15)$$

Remark 6.6. We observe that the condition $\mu_2\kappa \neq 0$ gives $\tilde{M}F_2G_8 \neq 0$ and the condition $\kappa > 0$ implies $\eta > 0$. Moreover we have

$$\text{sign}(\tilde{K}) = -\text{sign}(\kappa), \quad \text{sign}(G_8) = \text{sign}(\mu_2) = \text{sign}(F_2).$$

The subcase $\kappa < 0$. Then by Remark 6.6 we obtain $\tilde{K} > 0$.

(1) *The possibility $\mu_2 < 0$.* Then $1 + 2u < 0$, i.e. $u < -1/2$ and considering (6.15) we obtain $G_8 < 0$. So since $\tilde{K} > 0$, according to [5] (see Table 1, lines 165-170) both finite singularities are anti-saddles.

(a) *Assume first $W_4 < 0$.* Then we have a node and a focus and whether the focus is a weak one or not depends on the invariant polynomial \mathcal{T}_4 . On the other hand due to $W_4 \neq 0$ we have a generic node.

(a.1) *The case $\mathcal{T}_4 \neq 0$.* Then by [33] the focus is strong. (α) *The subcase $\eta < 0$.* Then at infinity we have one real and two complex singularities and as $\mu_2 < 0$ and $\kappa \neq 0$ considering Lemma 6.1 we get the global configuration of singularities

$$n, f; \overline{\begin{pmatrix} 2 \\ 1 \end{pmatrix}} S, \odot, \odot : \text{Example} \Rightarrow (c = 5, e = -1, u = -2).$$

(β) *The subcase $\eta > 0$.* In this case at infinity we have three real singularities. As $\kappa < 0$ and $\mu_2 < 0$, by Lemma 6.1 we get the configuration

$$n, f; \overline{\begin{pmatrix} 2 \\ 1 \end{pmatrix}} S, S, N^\infty : \text{Example} \Rightarrow (c = 1/2, e = -1/5, u = -2).$$

(γ) *The subcase $\eta = 0$.* In this case considering Remark 6.6 we have $\tilde{M} \neq 0$. As $\kappa \neq 0$ and $\mu_2 < 0$, considering Lemma 6.1 we get the global configuration of singularities

$$n, f; \overline{\begin{pmatrix} 0 \\ 2 \end{pmatrix}} SN, \overline{\begin{pmatrix} 2 \\ 1 \end{pmatrix}} S : \text{Example} \Rightarrow (c = 3, e = -1/16, u = -2).$$

(a.2) *The case $\mathcal{T}_4 = 0$.* Then by [33] the focus is weak. Considering (6.15) and the condition (6.13), the condition $\mathcal{T}_4 = 0$ gives $(c + 1)(2u + 1 - c) = \rho_1\rho_2 = 0$. By Remark 6.4 we may assume without loss of generality that $\rho_1 = 0$, i.e. $c = -1$. Then for systems (6.14) we calculate:

$$\begin{aligned}\mathcal{T}_3 &= 8(1 + e)^2u^2(1 + u)(1 + 2u), & \mathcal{F}_1 &= 2(1 + e)(u - 1)(1 + 2u), \\ \mu_2 &= (1 + e)^2(1 + 2u)x^2, & \kappa &= -128(1 + e)u^3, \\ W_4 &= -256(1 + e)^5u^4(1 + 2u)^2(e + 2eu - u^2).\end{aligned}\tag{6.16}$$

We observe that the condition $\mu_2 < 0$ implies $\mathcal{F}_1 \neq 0$. Moreover as $W_4 < 0$ we have $\mathcal{T}_3 \neq 0$, otherwise we get $u = -1$ and this gives $W_4 = 256(1 + e)^6 \geq 0$. Therefore by [33] the weak focus has order one, and according to Lemma 6.1 we obtain the following three global configurations of singularities:

$$\begin{aligned}n, f^{(1)}; \overline{\begin{pmatrix} 2 \\ 1 \end{pmatrix}}S, \textcircled{C}, \textcircled{C} : \text{Example} &\Rightarrow (c = -1, e = -3/2, u = -6/10) \quad (\text{if } \eta < 0); \\ n, f^{(1)}; \overline{\begin{pmatrix} 2 \\ 1 \end{pmatrix}}S, S, N^\infty : \text{Example} &\Rightarrow (c = -1, e = -51/50, u = -7/10) \\ &(\text{if } \eta > 0); \\ n, f^{(1)}; \overline{\begin{pmatrix} 0 \\ 2 \end{pmatrix}}SN, \overline{\begin{pmatrix} 2 \\ 1 \end{pmatrix}}S : \text{Example} &\Rightarrow (c = -1, e = -36/35, u = -7/10) \\ &(\text{if } \eta = 0).\end{aligned}$$

(b) *Suppose now $W_4 > 0$.* In this case as $\tilde{K} > 0$ and $G_8 < 0$, according to [5] systems (6.14) possess two nodes if $W_3 > 0$ and two foci or/and centers if $W_3 < 0$.

(b.1) *The case $W_3 < 0$.*

(α) *The subcase $\mathcal{T}_4 \neq 0$.* Then by [33] both foci are strong. Thus considering the conditions $\mu_0 = \mu_1 = 0$, $\mu_2 < 0$, $\kappa \neq 0$ and Lemma 6.1 we arrive at the following three global configurations of singularities:

$$\begin{aligned}f, f; \overline{\begin{pmatrix} 2 \\ 1 \end{pmatrix}}S, \textcircled{C}, \textcircled{C} : \text{Example} &\Rightarrow (c = 1, e = -1, u = -2) \quad (\text{if } \eta < 0); \\ f, f; \overline{\begin{pmatrix} 2 \\ 1 \end{pmatrix}}S, S, N^\infty : \text{Example} &\Rightarrow (c = 1, e = -1/2, u = -2) \quad (\text{if } \eta > 0); \\ f, f; \overline{\begin{pmatrix} 0 \\ 2 \end{pmatrix}}SN, \overline{\begin{pmatrix} 2 \\ 1 \end{pmatrix}}S : \text{Example} &\Rightarrow (c = 1, e = -9/16, u = -2) \quad (\text{if } \eta = 0).\end{aligned}$$

(β) *The subcase $\mathcal{T}_4 = 0$.* As it was mentioned earlier we may assume $c = -1$. Then at least one focus is a weak one.

(β .1) *The possibility $\mathcal{T}_3 \neq 0$.* In this case only one focus is weak. Moreover considering (6.16) we observe that the condition $\mu_2 < 0$ implies $\mathcal{F}_1 \neq 0$ and the weak focus could only be of the first order. So in view of the arguments above and Lemma 6.1 we get three global configurations of singularities:

$$\begin{aligned}f, f^{(1)}; \overline{\begin{pmatrix} 2 \\ 1 \end{pmatrix}}S, \textcircled{C}, \textcircled{C} : \text{Example} &\Rightarrow (c = -1, e = -2, u = -3/2) \quad (\text{if } \eta < 0); \\ f, f^{(1)}; \overline{\begin{pmatrix} 2 \\ 1 \end{pmatrix}}S, S, N^\infty : \text{Example} &\Rightarrow (c = -1, e = -5/4, u = -3/2) \quad (\text{if } \eta > 0);\end{aligned}$$

$f, f^{(1)}; \overline{\begin{pmatrix} 0 \\ 2 \end{pmatrix}}SN, \overline{\begin{pmatrix} 2 \\ 1 \end{pmatrix}}S$: Example $\Rightarrow (c = -1, e = -4/3, u = -3/2)$ (if $\eta = 0$).

($\beta.2$) *The possibility $\mathcal{T}_3 = 0$.* Considering (6.16) we get $u = -1$ and then we calculate:

$$\begin{aligned} \mathcal{T}_4 = \mathcal{T}_3 = \mathcal{F} = 0, \quad \mathcal{T}_2 = -4(1+e)^2, \quad \mathcal{F}_1 = 4(1+e), \\ \mu_2 = -(1+e)^2x^2, \quad \kappa = 128(1+e), \quad \eta = 4(9+8e). \end{aligned}$$

So the condition $\mu_2 \neq 0$ gives $\mathcal{F}_1 \neq 0$ and according to [33] we have two first order weak singularities, which in this case are foci.

Thus considering Lemma 6.1 we obtain the following three global configurations of singularities

$f^{(1)}, f^{(1)}; \overline{\begin{pmatrix} 2 \\ 1 \end{pmatrix}}S, \odot, \odot$: Example $\Rightarrow (c = -1, e = -2, u = -1)$ (if $\eta < 0$);

$f^{(1)}, f^{(1)}; \overline{\begin{pmatrix} 2 \\ 1 \end{pmatrix}}S, S, N^\infty$: Example $\Rightarrow (c = -1, e = -17/16, u = -1)$ (if $\eta > 0$);

$f^{(1)}, f^{(1)}; \overline{\begin{pmatrix} 0 \\ 2 \end{pmatrix}}SN, \overline{\begin{pmatrix} 2 \\ 1 \end{pmatrix}}S$: Example $\Rightarrow (c = -1, e = -9/8, u = -1)$ (if $\eta = 0$).

($\beta.2$) *The case $W_3 > 0$.* According to [5] (see Table 1, line 165) we have two nodes and both are generic (due to $W_4 \neq 0$). According to Lemma 6.1 we arrive at the following three global configurations of singularities:

$n, n; \overline{\begin{pmatrix} 2 \\ 1 \end{pmatrix}}S, \odot, \odot$: Example $\Rightarrow (c = 6, e = -1/3, u = -2)$ (if $\eta < 0$);

$n, n; \overline{\begin{pmatrix} 2 \\ 1 \end{pmatrix}}S, S, N^\infty$: Example $\Rightarrow (c = 6, e = -1/5, u = -2)$ (if $\eta > 0$);

$n, n; \overline{\begin{pmatrix} 0 \\ 2 \end{pmatrix}}SN, \overline{\begin{pmatrix} 2 \\ 1 \end{pmatrix}}S$: Example $\Rightarrow (c = 6, e = -1/4, u = -2)$ (if $\eta = 0$).

(c) *Admit finally $W_4 = 0$.* Then we have a node with coinciding eigenvalues and by Remark 6.4 without loss of generality we may assume that $M_1(0,0)$ is such a point. So the corresponding discriminant $\tau_1 = (c-1)^2 + 4e = 0$, and we obtain $e = -(c-1)^2/4$, and in this case calculations yield:

$$\begin{aligned} \mu_2 = (1+c)^4(1+2u)x^2/16, \quad \kappa = 32(1+c)^2u^3, \quad \eta = 4u^2(1+2u)(c^2+2u), \\ W_4 = 0, \quad W_3 = (1+c)^8u^4(1+u)(1+2u)^2(1+c^2+2u)/8, \\ \mathcal{T}_4 = -(1+c)^5(c-1-2u)u^2(1+2u)/4. \end{aligned} \tag{6.17}$$

($c.1$) *The case $W_3 < 0$.* According to [5] (see Table 1, line 168) we have one focus and one node which is n^d (as the Jacobian matrix is not diagonal).

(α) *The subcase $\mathcal{T}_4 \neq 0$.* Then the focus is strong and we get the following three global configurations of singularities

$n^d, f; \overline{\begin{pmatrix} 2 \\ 1 \end{pmatrix}}S, \odot, \odot$: Example $\Rightarrow (c = 2, e = -1/4, u = -3/2)$ (if $\eta < 0$);

$n^d, f; \overline{\begin{pmatrix} 2 \\ 1 \end{pmatrix}}S, S, N^\infty$: Example $\Rightarrow (c = 2, e = -1/4, u = -9/4)$ (if $\eta > 0$);

$$n^d, f; \overline{\binom{0}{2}}SN, \overline{\binom{2}{1}}S : \text{Example} \Rightarrow (c = 2, e = -1/4, u = -2) \quad (\text{if } \eta = 0).$$

(β) *The subcase $\mathcal{T}_4 = 0$.* Considering (6.17) and the condition $\mu_2\kappa \neq 0$ we obtain $(c - 1 - 2u) = 0$, i.e. $c = 2u + 1$. Then we calculate

$$\begin{aligned} \mathcal{T}_3 &= 8u^2(1+u)^5(1+2u), & \mathcal{F}_1 &= -2(1+u)^2(1+2u)(1+3u), \\ \eta &= 4u^2(1+2u)(1+6u+4u^2), & \mu_2 &= (1+u)^4(1+2u)x^2, \\ \kappa &= 128u^3(1+u)^2, & W_4 &= 0, & W_3 &= 64u^4(1+u)^{10}(1+2u)^3. \end{aligned} \quad (6.18)$$

So the conditions $W_3 \neq 0$ and $\mu_2 < 0$ implies $\mathcal{T}_3\mathcal{F}_1 \neq 0$ and according to [33] the focus $M_2(1, 0)$ is a weak focus of the first order. Therefore considering Lemma 6.1 we arrive at the following three global configurations of singularities

$$n^d, f^{(1)}; \overline{\binom{2}{1}}S, \odot, \odot : \text{Example} \Rightarrow (c = -2, e = -9/4, u = -3/2) \quad (\text{if } \eta < 0);$$

$$n^d, f^{(1)}; \overline{\binom{2}{1}}S, S, N^\infty : \text{Example} \Rightarrow (c = -7/5, e = -36/25, u = -6/5) \\ (\text{if } \eta > 0);$$

$$n^d, f^{(1)}; \overline{\binom{0}{2}}SN, \overline{\binom{2}{1}}S : \text{Example} \Rightarrow (c = 2u + 1, e = -(c - 1)^2/4, \\ u = -(3 + \sqrt{5})/4) \quad (\text{if } \eta = 0).$$

(c.2) *The case $W_3 > 0$.* According to [5] (see Table 1, line 166) we have two nodes (one of them being n^d).

Therefore considering Lemma 6.1 we get the following three global configurations of singularities:

$$n, n^d; \overline{\binom{2}{1}}S, \odot, \odot : \text{Example} \Rightarrow (c = 4/3, e = -1/36, u = -8/10) \quad (\text{if } \eta < 0);$$

$$n, n^d; \overline{\binom{2}{1}}S, S, N^\infty : \text{Example} \Rightarrow (c = 4/3, e = -1/36, u = -17/18) \quad (\text{if } \eta > 0);$$

$$n, n^d; \overline{\binom{0}{2}}SN, \overline{\binom{2}{1}}S : \text{Example} \Rightarrow (c = 4/3, e = -1/36, u = -8/9) \quad (\text{if } \eta = 0).$$

(c.3) *The case $W_3 = 0$.* Considering (6.17) and the condition $\mu_2 < 0$ we obtain $(1+u)(1+c^2+2u) = 0$ and in this case we have two nodes n^d (as no one of the Jacobian matrices is diagonal).

(α) *The subcase $u = -1$.* We have

$$\eta = 4(2 - c^2), \quad \mu_2 = -(1+c)^4x^2/16 < 0, \quad \kappa = -32(1+c)^2 < 0.$$

So considering Lemma 6.1 we obtain the following three global configurations of singularities:

$$n^d, n^d; \overline{\binom{2}{1}}S, \odot, \odot : \text{Example} \Rightarrow (c = 2, e = -1/4, u = -1) \quad (\text{if } \eta < 0);$$

$$n^d, n^d; \overline{\binom{2}{1}}S, S, N^\infty : \text{Example} \Rightarrow (c = 1/2, e = -1/16, u = -1) \quad (\text{if } \eta > 0);$$

$$n^d, n^d; \overline{\binom{0}{2}}SN, \overline{\binom{2}{1}}S : \text{Example} \Rightarrow (c = \sqrt{2}, e = -(c-1)^2/4, u = -1) \\ (\text{if } \eta = 0).$$

(β) *The subcase* $u = -(c^2 + 1)/2$. We calculate

$$\eta = c^2(1 + c^2)^2, \quad \mu_2 = -c^2(1 + c)^4x^2/16 < 0, \quad \kappa = -4(1 + c)^2(1 + c^2)^3 < 0$$

and in this case we could only have $\eta > 0$ and such a configuration was detected above.

(2) *The possibility* $\mu_2 > 0$. Then by (6.15) we have $1 + 2u > 0$ and this implies $G_8 > 0$. Since $\tilde{K} > 0$ according to [5] systems (6.14) possess a saddle and a focus (or a center) if $W_4 < 0$ and a saddle and a node if $W_4 \geq 0$.

(a) *Assume first* $W_4 < 0$, i.e. we have a saddle and a focus.

(a.1) *The subcase* $\mathcal{T}_4 \neq 0$. Then by [33] we could not have weak singularities. So considering Remark 6.6 and Lemma 6.1 we get the following three global configurations of singularities

$$s, f; \overline{\binom{2}{1}}N, \odot, \odot : \text{Example} \Rightarrow (c = -8, e = 2, u = 2) \quad (\text{if } \eta < 0); \\ s, f; \overline{\binom{2}{1}}N, S, N^\infty : \text{Example} \Rightarrow (c = -8, e = 1/2, u = 2) \quad (\text{if } \eta > 0); \\ s, f; \overline{\binom{0}{2}}SN, \overline{\binom{2}{1}}N : \text{Example} \Rightarrow (c = -8, e = 1, u = 2) \quad (\text{if } \eta = 0).$$

(a.2) *The subcase* $\mathcal{T}_4 = 0$. As it was shown earlier we can assume $c = -1$ and we calculate

$$\mathcal{T}_3\mathcal{F} = 8(1 + e)^3u^4(1 + u)^2(1 + 2u)^2.$$

Therefore considering (6.16) we conclude that the condition $\kappa < 0$ and $\mu_2 > 0$ imply $\mathcal{T}_3\mathcal{F} \neq 0$. Moreover, as $(1 + e)u > 0$ (due to $\kappa < 0$) from (6.16) we have

$$\text{sign}(\mathcal{T}_3\mathcal{F}) = \text{sign}(u), \quad \text{sign}(W_4) = \text{sign}(u(e + 2eu - u^2)). \quad (6.19)$$

(α) *The possibility* $\mathcal{T}_3\mathcal{F} < 0$. Then $u < 0$ and according to [33] systems (6.14) with $c = -1$ possess a weak focus. As $-1/2 < u < 0$ then $\mathcal{F}_1 \neq 0$ and we have a weak first order focus. So considering Lemma 6.1 we get the following three global configurations of singularities

$$s, f^{(1)}; \overline{\binom{2}{1}}N, \odot, \odot : \text{Example} \Rightarrow (c = -1, e = -2, u = -1/4) \quad (\text{if } \eta < 0); \\ s, f^{(1)}; \overline{\binom{2}{1}}N, S, N^\infty : \text{Example} \Rightarrow (c = -1, e = -17/16, u = -1/4) \quad (\text{if } \eta > 0); \\ s, f^{(1)}; \overline{\binom{0}{2}}SN, \overline{\binom{2}{1}}N : \text{Example} \Rightarrow (c = -1, e = -9/8, u = -1/4) \quad (\text{if } \eta = 0).$$

(β) *The possibility* $\mathcal{T}_3\mathcal{F} > 0$. In this case $u > 0$ and according to [33] systems (6.14) with $c = -1$ possess a weak saddle.

($\beta.1$) Assume first $\mathcal{F}_1 \neq 0$. The weak saddle has order one and considering Lemma 6.1 we obtain the following three global configurations of singularities:

$$\begin{aligned} s^{(1)}, f; \overline{\begin{pmatrix} 2 \\ 1 \end{pmatrix}} N, \odot, \odot : \text{Example} &\Rightarrow (c = -1, e = 1, u = 1/5) \quad (\text{if } \eta < 0); \\ s^{(1)}, f; \overline{\begin{pmatrix} 2 \\ 1 \end{pmatrix}} N, S, N^\infty : \text{Example} &\Rightarrow (c = -1, e = 1/5, u = 1/5) \quad (\text{if } \eta > 0); \\ s^{(1)}, f; \overline{\begin{pmatrix} 0 \\ 2 \end{pmatrix}} SN, \overline{\begin{pmatrix} 2 \\ 1 \end{pmatrix}} N : \text{Example} &\Rightarrow (c = -1, e = 9/40, u = 1/5) \quad (\text{if } \eta = 0). \end{aligned}$$

($\beta.2$) Suppose now that $\mathcal{F}_1 = 0$. Then $u = 1$ and we calculate

$$\begin{aligned} \mathcal{T}_3 \mathcal{F} &= 288(1+e)^3, \quad \mathcal{F}_1 = 0, \quad \mathcal{F}_2 = -432(1+e)^2, \\ \kappa &= -128(1+e), \quad \eta = 4(1-8e), \quad W_4 = 2304(1+e)^5(1-3e), \end{aligned} \tag{6.20}$$

and as $\kappa < 0$ we get $e+1 > 0$ and hence $\mathcal{F}_2 \neq 0$. Therefore as $\mathcal{T}_3 \mathcal{F} > 0$ and $\mathcal{F}_1 = 0$ by [33] we obtain a weak saddle of order two.

On the other hand the condition $W_4 < 0$ due to $e+1 > 0$ gives $e > 1/3$ and this implies $\eta < 0$.

Thus considering Lemma 6.1 we obtain the configuration

$$s^{(2)}, f; \overline{\begin{pmatrix} 2 \\ 1 \end{pmatrix}} N, \odot, \odot : \text{Example} \Rightarrow (c = -1, e = 1, u = 1).$$

(b) Suppose now that $W_4 > 0$, i.e. by [5] we have a saddle and a node.

(b.1) The subcase $\mathcal{T}_4 \neq 0$. Then by [33] we could not have weak singularities, i.e. the saddle is strong. So considering Lemma 6.1 we obtain the following three global configurations of singularities:

$$\begin{aligned} s, n; \overline{\begin{pmatrix} 2 \\ 1 \end{pmatrix}} N, \odot, \odot : \text{Example} &\Rightarrow (c = -2, e = 2/5, u = 2) \quad (\text{if } \eta < 0); \\ s, n; \overline{\begin{pmatrix} 2 \\ 1 \end{pmatrix}} N, S, N^\infty : \text{Example} &\Rightarrow (c = -2, e = 1/5, u = 2) \quad (\text{if } \eta > 0); \\ s, n; \overline{\begin{pmatrix} 0 \\ 2 \end{pmatrix}} SN, \overline{\begin{pmatrix} 2 \\ 1 \end{pmatrix}} N : \text{Example} &\Rightarrow (c = -2, e = 1/4, u = 2) \quad (\text{if } \eta = 0). \end{aligned}$$

(b.2) The subcase $\mathcal{T}_4 = 0$. As it was shown earlier we can assume $c = -1$ and considering (6.16) we conclude that the conditions $\kappa < 0$ and $\mu_2 > 0$ imply $\mathcal{T}_3 \neq 0$.

(α) Assume first $\mathcal{F}_1 \neq 0$. Then the weak saddle has order one and considering Lemma 6.1 we obtain the following three global configurations of singularities:

$$\begin{aligned} s^{(1)}, n; \overline{\begin{pmatrix} 2 \\ 1 \end{pmatrix}} N, \odot, \odot : \text{Example} &\Rightarrow (c = -1, e = 5/8, u = 2) \quad (\text{if } \eta < 0); \\ s^{(1)}, n; \overline{\begin{pmatrix} 2 \\ 1 \end{pmatrix}} N, S, N^\infty : \text{Example} &\Rightarrow (c = -1, e = 1/2, u = 2) \quad (\text{if } \eta > 0); \\ s^{(1)}, n; \overline{\begin{pmatrix} 0 \\ 2 \end{pmatrix}} SN, \overline{\begin{pmatrix} 2 \\ 1 \end{pmatrix}} N : \text{Example} &\Rightarrow (c = -1, e = 9/16, u = 2) \quad (\text{if } \eta = 0). \end{aligned}$$

(β) Suppose now $\mathcal{F}_1 = 0$. In this case we get $u = 1$ and considering (6.20) we deduce that the condition $\kappa < 0$ implies $\mathcal{F}_2 \neq 0$. Therefore according to [33]

we have a second order weak saddle and we arrive at the following three global configurations of singularities:

$$\begin{aligned} s^{(2)}, n; \overline{\begin{pmatrix} 2 \\ 1 \end{pmatrix}} N, \textcircled{C}, \textcircled{C} : \text{Example} &\Rightarrow (c = -1, e = 1/4, u = 1) \quad (\text{if } \eta < 0); \\ s^{(2)}, n; \overline{\begin{pmatrix} 2 \\ 1 \end{pmatrix}} N, S, N^\infty : \text{Example} &\Rightarrow (c = -1, e = 1/9, u = 1) \quad (\text{if } \eta > 0); \\ s^{(2)}, n; \overline{\begin{pmatrix} 0 \\ 2 \end{pmatrix}} SN, \overline{\begin{pmatrix} 2 \\ 1 \end{pmatrix}} N : \text{Example} &\Rightarrow (c = -1, e = 1/8, u = 1) \quad (\text{if } \eta = 0). \end{aligned}$$

(c) *Admit finally* $W_4 = 0$. As it was mentioned above in this case we may assume $e = -(c-1)^2/4$. On the other hand as $G_8 > 0$ and $\tilde{K} > 0$, according to [5] systems (6.14) possess a saddle and a node, which is n^d (due to $W_4 = 0$ and the fact that the jacobian is not diagonal). According to (6.17) the conditions $\kappa < 0$ and $\mu_2 > 0$ yield $-1/2 < u < 0$.

(c.1) *The subcase* $\mathcal{T}_4 \neq 0$. Then by [33] we could not have weak singularities, i.e. the saddle is strong. So considering Lemma 6.1 we obtain the following three global configurations of singularities:

$$\begin{aligned} s, n^d; \overline{\begin{pmatrix} 2 \\ 1 \end{pmatrix}} N, \textcircled{C}, \textcircled{C} : \text{Example} &\Rightarrow (c = 1/2, e = -1/16, u = -1/5) \quad (\text{if } \eta < 0); \\ s, n^d; \overline{\begin{pmatrix} 2 \\ 1 \end{pmatrix}} N, S, N^\infty : \text{Example} &\Rightarrow (c = 1/2, e = -1/16, u = -1/9) \quad (\text{if } \eta > 0); \\ s, n^d; \overline{\begin{pmatrix} 0 \\ 2 \end{pmatrix}} SN, \overline{\begin{pmatrix} 2 \\ 1 \end{pmatrix}} N : \text{Example} &\Rightarrow (c = 1/2, e = -1/16, u = -1/8) \quad (\text{if } \eta = 0). \end{aligned}$$

(c.2) *The subcase* $\mathcal{T}_4 = 0$. Considering (6.17) and the condition $\mu_2\kappa \neq 0$ we obtain $c - 1 - 2u = 0$, i.e. $c = 2u + 1$. Then we obtain (6.18) and we can observe that $\mathcal{T}_3 \neq 0$ (due to $\mu_2\kappa \neq 0$).

(α) *The possibility* $\mathcal{F}_1 \neq 0$. Then by [33] the weak saddle has order one and considering Lemma 6.1 we obtain the following three global configurations of singularities:

$$\begin{aligned} s^{(1)}, n^d; \overline{\begin{pmatrix} 2 \\ 1 \end{pmatrix}} N, \textcircled{C}, \textcircled{C} : \text{Example} &\Rightarrow (c = 1/2, e = -1/16, u = -1/4) \quad (\text{if } \eta < 0); \\ s^{(1)}, n^d; \overline{\begin{pmatrix} 2 \\ 1 \end{pmatrix}} N, S, N^\infty : \text{Example} &\Rightarrow (c = 2/3, e = -1/36, u = -1/6) \quad (\text{if } \eta > 0); \\ s^{(1)}, n^d; \overline{\begin{pmatrix} 0 \\ 2 \end{pmatrix}} SN, \overline{\begin{pmatrix} 2 \\ 1 \end{pmatrix}} N : \text{Example} &\Rightarrow (c = 2u + 1, e = -(c-1)^2/4, \\ &u = (\sqrt{5} - 3)/4) \quad (\text{if } \eta = 0). \end{aligned}$$

(β) *The possibility* $\mathcal{F}_1 = 0$. Considering (6.18) we obtain $u = -1/3$ and then we have

$$\mathcal{T}_4 = \mathcal{F}_1 = 0, \quad \mathcal{T}_3 = 256/6561, \quad \mathcal{F}_2 = -256/19683, \quad \eta = -20/243.$$

Hence by [33] the saddle is of the second order. As $\eta < 0$ considering Lemma 6.1 we obtain the configuration

$$s^{(2)}, n^d; \overline{\binom{2}{1}}N, \odot, \odot : \text{Example} \Rightarrow (c = 1/3, e = -1/9, u = -1/3).$$

The subcase $\kappa > 0$. According to (6.15) and Remark 6.6 the condition $\kappa > 0$ implies $\eta > 0$ and $\tilde{K} < 0$, and we consider two possibilities: $\mu_2 < 0$ and $\mu_2 > 0$.

(1) *The possibility $\mu_2 < 0$.* Then $u < -1/2$ and considering (6.15) we obtain $F_2 < 0$ and $G_8 < 0$. As $\tilde{K} < 0$ according to [5] (see Table 1, line 148) both finite singularities are saddles.

On the other hand according to Lemma 6.1 due to $\eta > 0$, $\kappa > 0$ and $\mu_2 < 0$ at infinity we have the configuration $\overline{\binom{2}{1}}N, N^f, N^f$.

(b) *Assume first $\mathcal{T}_4 \neq 0$,* i.e. both saddles are strong and this leads to the global configuration of singularities

$$s, s; \overline{\binom{2}{1}}N, N^f, N^f : \text{Example} \Rightarrow (c = -2, e = 0, u = -2).$$

(b) *Suppose now $\mathcal{T}_4 = 0$.* As it was shown earlier we can assume $c = -1$ and we consider (6.16).

(b.1) *The case $\mathcal{T}_3 \neq 0$.* In this situation only one saddle is weak and as $\mathcal{F}_1 \neq 0$ (due to $\mu_2 < 0$), according to [33] the order of the weak saddle is one and we get the configuration

$$s, s^{(1)}; \overline{\binom{2}{1}}N, N^f, N^f : \text{Example} \Rightarrow (c = -1, e = 1, u = -2).$$

(b.2) *The case $\mathcal{T}_3 = 0$.* Then $u = -1$ and we have

$$\mathcal{T}_4 = \mathcal{T}_3 = \mathcal{F} = 0, \quad \mathcal{T}_2 = -4(1+e)^2, \quad \mathcal{F}_1 = 4(1+e), \quad \mu_2 = -(1+e)^2 x^2 \neq 0.$$

Hence $\mathcal{T}_2 < 0$ and as $\mathcal{F}_1 \neq 0$ according to [33] we have two weak saddles each one of the first order

$$s^{(1)}, s^{(1)}; \overline{\binom{2}{1}}N, N^f, N^f : \text{Example} \Rightarrow (c = -1, e = 1, u = -1).$$

(2) *The possibility $\mu_2 > 0$.* In this case we have $u > -1/2$ and considering (6.15) we obtain $F_2 > 0$ and $G_8 > 0$. As $\tilde{K} < 0$ according to [5] (see Table 1, lines 149,156,161) we have a saddle and an anti-saddle. The type of the anti-saddle is governed by invariant polynomial W_4 .

On the other hand due to the condition $\eta > 0$, $\kappa > 0$, $\mu_2 > 0$ and considering Remark 6.6, according to Lemma 6.1 at infinity we have the configuration $\overline{\binom{2}{1}}S, N^f, N^f$.

(a) *Assume first $W_4 < 0$,* i.e. we have a saddle and a focus or a center.

(a.1) *The case $\mathcal{T}_4 \neq 0$.* Then by [33] we could not have weak singularities i.e. the saddle and the focus are both strong ones. Thus we get the global configuration of singularities

$$s, f; \overline{\binom{2}{1}}S, N^f, N^f : \text{Example} \Rightarrow (c = 1, e = -1, u = 2).$$

(a.2) *The subcase $\mathcal{T}_4 = 0$.* As it was shown earlier we can assume $c = -1$ and considering (6.16) we conclude that the condition $\kappa > 0$ and $\mu_2 > 0$ imply $\mathcal{T}_3 \neq 0$. Moreover as $(1 + e)u < 0$ (due to $\kappa > 0$) we have $\text{sign}(\mathcal{T}_3\mathcal{F}) = -\text{sign}(u)$.

(α) *The possibility $\mathcal{T}_3\mathcal{F} < 0$.* Then $u > 0$ and in this case according to [33] systems (6.14) with $c = -1$ possess a weak focus.

($\alpha.1$) *Assume first $\mathcal{F}_1 \neq 0$.* In this case by [33] the weak focus is of order one and this leads to the configuration

$$s, f^{(1)}; \overline{\begin{pmatrix} 2 \\ 1 \end{pmatrix}} S, N^f, N^f : \text{Example} \Rightarrow (c = -1, e = -2, u = 2).$$

($\alpha.2$) *Admit now that $\mathcal{F}_1 = 0$.* Then $u = 1$, $e < -1$ and this implies $\mathcal{F}_2 = -432(1 + e)^2 \neq 0$. So by [33] we could have a weak focus of the order at most two and this leads to the configuration

$$s, f^{(2)}; \overline{\begin{pmatrix} 2 \\ 1 \end{pmatrix}} S, N^f, N^f : \text{Example} \Rightarrow (c = -1, e = -2, u = 1).$$

(β) *The possibility $\mathcal{T}_3\mathcal{F} > 0$.* Then $u < 0$ and in this case according to [33] systems (6.14) with $c = -1$ possess a weak saddle. As $-1/2 < u < 0$ then $\mathcal{F}_1 \neq 0$ and we have a weak saddle of order one. Thus we get the configuration

$$s^{(1)}, f; \overline{\begin{pmatrix} 2 \\ 1 \end{pmatrix}} S, N^f, N^f : \text{Example} \Rightarrow (c = -1, e = 1/2, u = -1/4).$$

(b) *Suppose now $W_4 > 0$.* By [5] besides the saddle we have a node (which is generic due to $W_4 \neq 0$).

(b.1) *The subcase $\mathcal{T}_4 \neq 0$.* Then by [33] we could not have weak singularities and this leads to the configuration of singularities

$$s, n; \overline{\begin{pmatrix} 2 \\ 1 \end{pmatrix}} S, N^f, N^f : \text{Example} \Rightarrow (c = 2, e = 1, u = 2).$$

(b.2) *The subcase $\mathcal{T}_4 = 0$.* As it was shown earlier we can assume $c = -1$ and considering (6.16) we conclude that the condition $\kappa > 0$ and $\mu_2 > 0$ imply $\mathcal{T}_3 \neq 0$. Moreover we claim that in this case the condition $\mathcal{F}_1 \neq 0$ holds. Indeed assuming $\mathcal{F}_1 = 0$ by (6.16) we obtain $u = 1$ and then the conditions

$$\kappa = -128(1 + e) > 0, \quad W_4 = 2304(1 + e)^5(1 - 3e) > 0$$

are incompatible. Thus $\mathcal{F}_1 \neq 0$ and we have a weak saddle of order one, i.e. we get the configuration

$$s^{(1)}, n; \overline{\begin{pmatrix} 2 \\ 1 \end{pmatrix}} S, N^f, N^f : \text{Example} \Rightarrow (c = -1, e = -1/2, u = -1/3).$$

(c) *Admit finally that $W_4 = 0$.* As it was mentioned above in this case we may assume $e = -(c - 1)^2/4$ (i.e. $\tau_1 = 0$). On the other hand as $G_8 > 0$, $F_2 > 0$ and $\tilde{K} < 0$ according to [5] (see Table 1, line 151) systems (6.14) possess a saddle and a node, which is n^d (due to $W_4 = 0$ and the non-diagonal corresponding matrix of the linearization). According to (6.17) the condition $\kappa > 0$ yields $u > 0$.

(c.1) *The subcase $\mathcal{T}_4 \neq 0$.* Then by [33] we could not have weak singularities, i.e. the saddle is strong. So we get the configuration

$$s, n^d; \overline{\binom{2}{1}} S, N^f, N^f : \text{Example} \Rightarrow (c = 1, e = 0, u = 1).$$

(c.2) *The subcase $\mathcal{T}_4 = 0$.* Considering (6.17) and the condition $\mu_2\kappa \neq 0$ we get $c-1-2u = 0$, i.e. $c = 2u+1$. Then we obtain (6.18) and we observe that $\mathcal{T}_3 \neq 0$ (due to $\mu_2\kappa \neq 0$). Moreover in this case we obtain $\mathcal{F}_1 = -2(1+u)^2(1+2u)(1+3u) \neq 0$ due to $u > 0$. Therefore we have a weak saddle of order one and this leads to the configuration

$$s^{(1)}, n^d; \overline{\binom{2}{1}} S, N^f, N^f : \text{Example} \Rightarrow (c = 3, e = -1, u = 1).$$

As all the cases have been examined the investigation of systems (6.14) is completed.

B. Systems with $d = 1, f = 0$. In this case for systems (6.11) with $d = 1$ and $f = 0$ we calculate

$$\kappa = -128eu^3, \quad \mu_2 = e^2(1+2u)x^2, \quad \mathcal{T}_4 = -4c^2e^2u^2(1+2u).$$

We observe that due to $\mu_2\kappa \neq 0$ the condition $c \neq 0$ is equivalent to $\mathcal{T}_4 \neq 0$.

The subcase $\mathcal{T}_4 \neq 0$. Then $c \neq 0$ and we may assume $c = 1$ due to the rescaling $(x, y, t) \mapsto (x, cy, t/c)$. So we get the 2-parameter family of systems

$$\dot{x} = x + y - x^2 + 2uxy, \quad \dot{y} = ex - ex^2, \quad eu(1+2u) \neq 0, \quad (6.21)$$

for which we calculate

$$\begin{aligned} \mu_0 = \mu_1 = 0, \quad \mu_2 = e^2(1+2u)x^2, \quad \tilde{K} = 4eux^2, \quad \kappa = -128eu^3, \\ \eta = 4u^2(1-8eu), \quad F_2 = e^2(1+2u)x^2, \quad G_8 = 2e^2u^2(1+2u), \\ W_4 = 16e^4(1+4e)u^4(1+2u)^2(1-4e-8eu), \end{aligned} \quad (6.22)$$

$$W_3 = 32e^4u^4(1+2u)^2(1-4eu), \quad \tilde{M} = 8(6eu-1)x^2 + 16uxy - 32u^2y^2.$$

Remark 6.7. We observe that the condition $\mu_2\kappa \neq 0$ gives $\tilde{M}F_2G_8 \neq 0$. Moreover we have

$$\text{sign}(\tilde{K}) = -\text{sign}(\kappa), \quad \text{sign}(G_8) = \text{sign}(\mu_2) = \text{sign}(F_2).$$

We observe that for systems (6.21) the same relations between the signs of invariant polynomials as in the case of systems (6.14) hold. Moreover as we shall use the same Table 1 of [5] and the same conditions for infinite singularities (i.e. Lemma 6.1), we only need to detect if for systems (6.21) we could obtain some configurations, which we have not obtained for systems (6.14).

For this goal we only need to detect if some logically possible configurations of singularities in the case $\mathcal{T}_4 \neq 0$ could not be realized for systems (6.14). And then to examine the respective case for systems (6.21) and to find out if such detected configuration could be realized for systems (6.21).

(1) *The possibility $\kappa < 0$.* We observe that all the logically possible configurations for systems (6.11) in the case $\kappa < 0$ and $\mathcal{T}_4 \neq 0$ are realized. More precisely we have the following number of configurations in the mentioned case

$$\mu_2 < 0, W_4 < 0 \Rightarrow 3; \quad \mu_2 < 0, W_4 > 0 \Rightarrow 6;$$

$$\begin{aligned} \mu_2 < 0, W_4 = 0 &\Rightarrow 9; & \mu_2 > 0, W_4 < 0 &\Rightarrow 3; \\ \mu_2 > 0, W_4 > 0 &\Rightarrow 3; & \mu_2 > 0, W_4 = 0 &\Rightarrow 3. \end{aligned}$$

(2) *The possibility $\kappa > 0$.* In this case by (6.15) the condition $\kappa > 0$ implies $\eta > 0$ for systems (6.14), i.e. the configurations with $\eta \leq 0$ do not exist for these systems.

The question is: *Could we obtain such configurations for systems (6.21)?* The answer is *no*, as from (6.22) we observe that the condition $\kappa > 0$ gives $eu < 0$ and then clearly $\eta > 0$.

Considering Remark 6.7 and [5] we conclude that all logical possibilities for configurations in the case $\kappa > 0$ and $\mathcal{T}_4 \neq 0$ are realized for systems (6.14). More precisely we have the following number of configurations in the mentioned case

$$\begin{aligned} \mu_2 < 0 &\Rightarrow 1; & \mu_2 > 0, W_4 < 0 &\Rightarrow 1; \\ \mu_2 > 0, W_4 > 0 &\Rightarrow 1; & \mu_2 > 0, W_4 = 0 &\Rightarrow 1. \end{aligned}$$

Thus we consider now the next possibility.

The subcase $\mathcal{T}_4 = 0$. Then $c = 0$ and we get the systems

$$\dot{x} = (1 + 2ux)y, \quad \dot{y} = ex - ex^2, \quad eu(1 + 2u) \neq 0. \quad (6.23)$$

Moreover due to the rescaling $(x, y, t) \mapsto (x, |e|^{1/2}y, |e|^{-1/2}t)$ we can assume $e \in \{-1, 1\}$.

For these systems we calculate

$$\begin{aligned} \mu_0 = \mu_1 = 0, \quad \mu_2 = e^2(1 + 2u)x^2, \quad \tilde{K} = 4eux^2, \quad \kappa = -128eu^3, \quad \eta = -32eu^3, \\ \tilde{M} = 16u(3ex^2 - 2uy^2), \quad F_2 = e^2(1 + 2u)x^2, \quad G_8 = 2e^2u^2(1 + 2u), \\ W_4 = -256e^6u^4(1 + 2u)^3, \quad W_3 = -128e^5u^5(1 + 2u)^2, \\ \mathcal{T}_4 = \mathcal{T}_3 = \mathcal{F}_1 = \mathcal{F} = 0, \quad \mathcal{T}_2 = 4e^2u^2(1 + 2u), \quad \mathcal{B} = -2e^2u^4, \quad \mathcal{H} = -4eu^3. \end{aligned} \quad (6.24)$$

As $\mathcal{T}_4 = \mathcal{T}_3 = \mathcal{F} = 0$ according to [33] systems (6.23) possess two weak singularities. Moreover, since $\mathcal{F}_1 = 0$ these singularities could be only centers and/or integrable saddles. We observe that due to $\mu_2\tilde{K} \neq 0$ we have

$$\begin{aligned} \text{sign}(\eta) = \text{sign}(\mathcal{H}) = \text{sign}(\kappa) = -\text{sign}(\tilde{K}), \\ \text{sign}(G_8) = \text{sign}(\mu_2) = \text{sign}(\mathcal{T}_2) = \text{sign}(F_2). \end{aligned} \quad (6.25)$$

(1) *The possibility $\kappa < 0$.* In this case we get $\eta < 0$ and $\mathcal{H} < 0$.

(a) *The case $\mu_2 < 0$.* This implies $\mathcal{T}_2 < 0$ and as $\mathcal{H} < 0$ and $\mathcal{B} < 0$, according to [33] we have two centers. Therefore considering Lemma 6.1 we get the global configuration of singularities

$$c, c; \overline{\begin{pmatrix} 2 \\ 1 \end{pmatrix}} S, \odot, \odot : \text{Example} \Rightarrow (e = -1, u = -1).$$

(b) *The case $\mu_2 > 0$.* Then $\mathcal{T}_2 > 0$ and as $\mathcal{B} < 0$, according to [33] we have one saddle and one center. At infinity we have the same configuration and we get

$$s, c; \overline{\begin{pmatrix} 2 \\ 1 \end{pmatrix}} N, \odot, \odot : \text{Example} \Rightarrow (e = 1, u = 1).$$

(2) *The possibility $\kappa > 0$.* In this case by (6.25) we have $\eta > 0$ and $\mathcal{H} > 0$.

(a) *The case $\mu_2 < 0$.* Then $\mathcal{T}_2 < 0$ and since $\mathcal{H} > 0$ and $\mathcal{B} < 0$, according to [33] we have two integrable saddles. On the other hand considering the signs of the invariant polynomials μ_2, κ and η according to Lemma 6.1 we get the global configuration of singularities

$$s, s; \overline{\binom{2}{1}}N, N^f, N^f : \text{Example} \Rightarrow (e = 1, u = -1).$$

(b) *The case $\mu_2 > 0$.* Then we obtain $\mathcal{T}_2 > 0$ and as $\mathcal{B} < 0$, according to [33] we have one saddle and one center. So considering Lemma 6.1 we get the configuration

$$s, c; \overline{\binom{2}{1}}S, N^f, N^f : \text{Example} \Rightarrow (e = -1, u = 1).$$

Thus in the case $\kappa \neq 0$ all the possibilities are examined for systems (6.11).

We observe that the four configurations detected for systems (6.23) are not realizable for systems (6.14). In order to insert these configurations in the global diagram we use the next remark.

Remark 6.8. For the four configurations above the following conditions are satisfied, respectively:

$$c, c; \overline{\binom{2}{1}}S, \textcircled{C}, \textcircled{C} \Rightarrow \kappa < 0, \mu_2 < 0, W_4 > 0, W_3 < 0, \mathcal{T}_4 = \mathcal{T}_3 = \mathcal{F}_1 = 0;$$

$$s, c; \overline{\binom{2}{1}}N, \textcircled{C}, \textcircled{C} \Rightarrow \kappa < 0, \mu_2 > 0, W_4 < 0, \mathcal{T}_4 = \mathcal{T}_3 = \mathcal{F}_1 = 0;$$

$$s, s; \overline{\binom{2}{1}}N, N^f, N^f \Rightarrow \kappa > 0, \mu_2 < 0, W_4 > 0, W_3 > 0, \mathcal{T}_4 = \mathcal{T}_3 = \mathcal{F}_1 = 0;$$

$$s, c; \overline{\binom{2}{1}}S, N^f, N^f \Rightarrow \kappa > 0, \mu_2 > 0, W_4 < 0, \mathcal{T}_4 = \mathcal{T}_3 = \mathcal{F}_1 = 0;$$

The case $\kappa = 0$. Considering (6.12) due to $\tilde{K} \neq 0$ we obtain $d = 0$ and then by Remark 6.5 we may assume $f = 1$. Thus we arrive at the following systems

$$\begin{aligned} \dot{x} &= cx(1-x), & cu(1+2u) &\neq 0, \\ \dot{y} &= ex+y-ex^2+2uxy, \end{aligned} \tag{6.26}$$

for which due to the rescaling $(x, y, t) \mapsto (x, ey, t)$ (if $e \neq 0$) we can assume $e \in \{0, 1\}$. For these systems we calculate

$$\begin{aligned} \mu_0 &= \mu_1 = \kappa = \kappa_1 = 0, & \mu_2 &= c^2(1+2u)x^2, & \tilde{K} &= -4cux^2, \\ \tilde{L} &= 8c(c+2u)x^2, & K_2 &= 96c^2(c^2+3cu+4u^2)x^2, \\ \eta &= 0, & \tilde{M} &= -8(c+2u)^2x^2, & C_2 &= ex^3 - (c+2u)x^2y, & G_8 &= 0, \\ F_2 &= c^2(1+2u)x^2, & \mathcal{T}_i &= 0, \quad (i = 1, 2, 3, 4), & \sigma &= 1+c-2(c-u)x, \\ \mathcal{F}_1 &= \mathcal{H} = \mathcal{B} = \mathcal{B}_1 = \mathcal{B}_2 = 0, & \mathcal{B}_3 &= 72c^2(1+c)(1-c+2u)x^2 \equiv 72c^2\rho_1\rho_2x^2. \end{aligned} \tag{6.27}$$

Considering the values of the above invariant polynomials according to [33] (see the Main Theorem) we arrive at the following remark.

Remark 6.9. Systems (6.26) possess at least one weak singularity if and only if $\mathcal{B}_3 = 0$. More exactly as $\tilde{K} \neq 0$, by [33] we have one integrable saddle in the case

$\sigma \neq 0$ (the statement $(e_3)[\gamma]$), and we have two integrable saddles in the case $\sigma = 0$ (the statement $(f_4)[\gamma]$).

The subcase $\tilde{K} < 0$. As $G_8 = 0$ according to [5] (see Table 1, lines 148, 150) we have two saddles if $F_2 < 0$ and a saddle and a node if $F_2 > 0$. On the other hand from (6.27) it follows $\text{sign}(F_2) = \text{sign}(\mu_2)$.

(1) *The possibility $\mu_2 < 0$.* Then $F_2 < 0$ and systems (6.27) possess two saddles.

On the other hand by (6.27) the condition $\tilde{K} < 0$ gives $cu > 0$ and then $\tilde{M} \neq 0$. Therefore as $\tilde{K} < 0$ and $\mu_2 < 0$ according to Lemma 6.1 and Remark 6.9 we arrive at the following three global configurations of singularities:

$$s, s; \begin{pmatrix} 2 \\ 2 \end{pmatrix} \widehat{P}E\widehat{P} - \widehat{P}E\widehat{P}, N^f : \text{Example} \Rightarrow (c = -2, e = 0, u = -1) \\ \text{(if } \sigma \mathcal{B}_3 \neq 0\text{);}$$

$$s, s; \begin{pmatrix} 2 \\ 2 \end{pmatrix} \widehat{P}E\widehat{P} - \widehat{P}E\widehat{P}, N^f : \text{Example} \Rightarrow (c = -1, e = 0, u = -2) \\ \text{(if } \sigma \neq 0, \mathcal{B}_3 = 0\text{);}$$

$$s, s; \begin{pmatrix} 2 \\ 2 \end{pmatrix} \widehat{P}E\widehat{P} - \widehat{P}E\widehat{P}, N^f : \text{Example} \Rightarrow (c = -1, e = 0, u = -1) \quad \text{(if } \sigma = 0\text{)}.$$

(2) *The possibility $\mu_2 > 0$.* Then $F_2 > 0$ and systems (6.27) possess one saddle and one node. We observe that the Jacobian matrices for the singularities $M_1(0, 0)$ and $M_2(1, 0)$ are:

$$M_1 \Rightarrow \begin{pmatrix} c & 0 \\ e & 1 \end{pmatrix}; \quad M_2 \Rightarrow \begin{pmatrix} -c & 0 \\ -e & 1 + 2u \end{pmatrix}.$$

Therefore systems (6.26) possess a node with coinciding eigenvalues if and only if $(c-1)(c+2u+1) = 0$, and this node is a star node if and only if $(c-1)(c+2u+1) = e = 0$.

On the other hand for these systems we have $W_{11} = 96cu^3(1-c)(1+c+2u)x^4$ and

$$U_3|_{c=1} = -24eu(1+u)^2x^5, \quad U_3|_{c=-1-2u} = 24eu(1+u)^2(1+2u)x^5.$$

Since the conditions $\tilde{K} \neq 0$ and $\mu_2 > 0$ imply $cu(1+u)(1+2u) \neq 0$ we have the next remark.

Remark 6.10. Systems (6.26) with $\mu_2 > 0$ possess a node with coinciding eigenvalues if and only if $W_{11} = 0$. Moreover this node is n^d if $U_3 \neq 0$ and it is a star node if $U_3 = 0$.

(a) *The case $W_{11} \neq 0$.* Then the node is generic. We observe that in this case $\sigma \neq 0$, otherwise we get $c = u = -1$ and this contradicts $\mu_2 > 0$.

(a.1) *The subcase $\mathcal{B}_3 \neq 0$.* Then by Remark 6.9 the saddle is strong and we shall examine the infinite singularities. We have again $\tilde{M} \neq 0$ (due to $cu > 0$) and considering (6.27) we obtain $K_2 > 0$. So according to Lemma 6.1 we get the configuration

$$s, n; \begin{pmatrix} 2 \\ 2 \end{pmatrix} \widehat{P}\widehat{P}H - \widehat{P}\widehat{P}H, N^f : \text{Example} \Rightarrow (c = 2, e = 0, u = 1).$$

(a.2) *The subcase $\mathcal{B}_3 = 0$.* Since $\sigma \neq 0$, by Remark 6.9 we have an integrable saddle and we arrive at the global configuration

$$s, n; \binom{2}{2} \widehat{P}\widehat{P}H - \widetilde{P}\widetilde{P}H, N^f : \text{Example } (c = -1, e = 0, u = -1/3).$$

(b) *The case $W_{11} = 0$.* Then one of the finite singularities is a node with coinciding eigenvalues. Due to the Remark 6.4 without loss of generality we may assume that such a node is $M_1(0, 0)$, i.e. the condition $c = 1$ holds.

(b.1) *The subcase $U_3 \neq 0$.* Then $e \neq 0$ and by Remark 6.10 besides the saddle we have a node n^d . On the other hand if $c = 1$ then $u > 0$ (due to $\widetilde{K} < 0$) and we obtain $\mathcal{B}_3 \neq 0$, i.e. the saddle is strong. Thus we obtain the configuration

$$s, n^d; \binom{2}{2} \widehat{P}\widehat{P}H - \widetilde{P}\widetilde{P}H, N^f : \text{Example } (c = 1, e = 1, u = 1).$$

(b.2) *The subcase $U_3 = 0$.* In this case we have a star node and a strong saddle and this leads to the global configuration of singularities

$$s, n^*; \binom{2}{2} \widehat{P}\widehat{P}H - \widetilde{P}\widetilde{P}H, N^f : \text{Example } (c = 1, e = 0, u = 1).$$

The subcase $\widetilde{K} > 0$. Since $G_8 = 0$ according to [5] the types of the finite singularities of systems (6.26) are governed by the polynomial F_2 .

(1) *The possibility $\mu_2 < 0$.* Then $F_2 < 0$ and as $G_8 = 0$ according to [5] (see Table 1, line 164) systems (6.26) possess two nodes.

(a) *The case $\widetilde{M} \neq 0$.* Then at infinity we have two real distinct singularities.

(a.1) *The subcase $W_{11} \neq 0$.* Then by Remark 6.10 both nodes are generic. On the other hand according to Lemma 6.1 the configuration of the infinite singularities depends on the sign of the invariant polynomial \widetilde{L} (we note that $\widetilde{L} \neq 0$ due to $\widetilde{M} \neq 0$). So we get the following two global configurations of singularities

$$\begin{aligned} n, n; \binom{2}{2} \widehat{P}H\widehat{P} - \widetilde{P}H\widetilde{P}, S : \text{Example } \Rightarrow (c = 2, e = 0, u = -2) \quad (\text{if } \widetilde{L} < 0); \\ n, n; \binom{2}{2} HHH - HHH, N^\infty : \text{Example } \Rightarrow (c = 2, e = 0, u = -2/3) \\ (\text{if } \widetilde{L} > 0). \end{aligned}$$

(a.2) *The subcase $W_{11} = 0$.* Then we may assume $c = 1$ and hence the singular point M_1 of systems (6.26) is a node with coinciding eigenvalues, whereas for the second singularity M_2 we have $\lambda_1 = -1$ and $\lambda_2 = 2u + 1$. Therefore the second node will be a node with coinciding eigenvalues if and only if $u = -1$. For $c = 1$ for systems (6.26) we calculate

$$\begin{aligned} U_1 = -4u(1+u)x^2, \quad U_3 = -24eu(1+u)^2x^5, \quad \mu_2 = (1+2u)x^2, \\ \widetilde{K} = -4ux^2, \quad U_5|_{u=-1} = -6ex^2, \quad \widetilde{L} = 8(2u+1) \end{aligned} \quad (6.28)$$

and due to $\widetilde{K} \neq 0$ the condition $u = -1$ is equivalent to $U_1 = 0$. Moreover if $U_1 \neq 0$ the condition $e = 0$ (to have a star node) is equivalent to $U_3 = 0$. In the case $U_1 = 0$ (i.e. $u = -1$) the condition $e = 0$ is equivalent to $U_5 = 0$ and in this case we have two star nodes.

On the other hand due to $\mu_2 \tilde{K} \neq 0$ we get $\tilde{L} < 0$. Thus considering Lemma 6.1 we arrive at the following four global configurations of singularities

$$n, n^d; \binom{2}{2} \widehat{P}H\widehat{P} - \widehat{P}H\widehat{P}, S : \text{Example} \Rightarrow (c = 1, e = 1, u = -2) \\ (\text{if } U_1 \neq 0, U_3 \neq 0);$$

$$n, n^*; \binom{2}{2} \widehat{P}H\widehat{P} - \widehat{P}H\widehat{P}, S : \text{Example} \Rightarrow (c = 1, e = 0, u = -2) \\ (\text{if } U_1 \neq 0, U_3 = 0);$$

$$n^d, n^d; \binom{2}{2} \widehat{P}H\widehat{P} - \widehat{P}H\widehat{P}, S : \text{Example} \Rightarrow (c = 1, e = 1, u = -1) \\ (\text{if } U_1 = 0, U_5 \neq 0);$$

$$n^*, n^*; \binom{2}{2} \widehat{P}H\widehat{P} - \widehat{P}H\widehat{P}, S : \text{Example} \Rightarrow (c = 1, e = 0, u = -1) \\ (\text{if } U_1 = 0, U_5 = 0).$$

(b) *The case $\widetilde{M} = 0$.* Then we have $c = -2u$ and this gives $C_2 = ex^3$ and $W_{11} = -192u^4(1 + 2u)x^4 \neq 0$ (due to $\mu_2 \neq 0$). Therefore at infinity we have one real singularity of multiplicity five if $C_2 \neq 0$ and the infinite line is filled up with singularities if $C_2 = 0$. At the same time due to Remark 6.10 systems (6.26) possess two generic nodes.

(b.1) *The subcase $C_2 \neq 0$.* As $\tilde{K} \neq 0$ and $\mu_2 < 0$ according to Lemma 6.1 we arrive at the global configuration of singularities

$$n, n; \binom{2}{3} HH\widehat{P} - \widehat{P}HH : \text{Example} \Rightarrow (c = 2, e = 1, u = -1).$$

(b.2) *The subcase $C_2 = 0$.* Then we have $c + 2u = e = 0$ and as the nodes are generic, considering Lemma 6.1 we obtain the configuration

$$n, n; [\infty; S] : \text{Example} \Rightarrow (c = 2, e = 0, u = -1).$$

(2) *The possibility $\mu_2 > 0$.* Then $F_2 > 0$ and as $G_8 = 0$ according to [5] (see Table 1, line 150) systems (6.27) possess a saddle and a node. We observe that due to $\tilde{K} > 0$ and $\mu_2 > 0$ in this case the conditions $2u + 1 > 0$ and $cu < 0$ hold.

(a) *The case $\widetilde{M} \neq 0$.* Then at infinity we have two real distinct singularities.

(a.1) *The subcase $\mathcal{B}_3 \neq 0$.* Then by Remark 6.9 the saddle is strong.

(α) *The possibility $W_{11} \neq 0$.* In this case the node is generic and as $\tilde{K} \neq 0$, $K_2 > 0$ and $\mu_2 > 0$ considering Lemma 6.1 we arrive at the following two global configurations of singularities

$$s, n; \binom{2}{2} \widehat{P}\widehat{P}E - \widehat{P}\widehat{P}E, S : \text{Example} \Rightarrow (c = -2, e = 0, u = 2) \quad (\text{if } \tilde{L} < 0);$$

$$s, n; \binom{2}{2} \widehat{P}\widehat{P}H - \widehat{P}\widehat{P}H, N^\infty : \text{Example} \Rightarrow (c = -2, e = 0, u = 1/4) \quad (\text{if } \tilde{L} > 0).$$

(β) *The possibility $W_{11} = 0$.* Then we may assume $c = 1$ and considering (6.28) the condition $\mu_2 > 0$ implies $\tilde{L} = 8(1 + 2u)x^2 > 0$. Moreover in this case the

condition $e = 0$ is equivalent to $U_3 = 0$. As a result we get the following two global configurations of singularities:

$$s, n^d; \binom{2}{2} \widehat{P}\widehat{P}H - \widehat{P}\widehat{P}H, N^\infty : \text{Example} \Rightarrow (c = 1, e = 1, u = -1/4)$$

$$\text{(if } U_3 \neq 0\text{);}$$

$$s, n^*; \binom{2}{2} \widehat{P}\widehat{P}H - \widehat{P}\widehat{P}H, N^\infty : \text{Example} \Rightarrow (c = 1, e = 0, u = -1/4)$$

$$\text{(if } U_3 = 0\text{)}.$$

(a.2) *The subcase $\mathcal{B}_3 = 0$.* By Remark 6.9 we have an integrable saddle and we may assume that it is located at $M_1(0, 0)$, i.e. $c = -1$. Then we have $W_{11} = -384u^4x^4 \neq 0$ and by Remark 6.10 the node is generic. Considering Lemma 6.1 we arrive at the following two global configurations of singularities:

$$s, n; \binom{2}{2} \widehat{P}\widehat{P}E - \widehat{P}\widehat{P}E, S : \text{Example} \Rightarrow (c = -1, e = 0, u = 2)$$

$$\text{(if } \widetilde{L} < 0\text{);}$$

$$s, n; \binom{2}{2} \widehat{P}\widehat{P}H - \widehat{P}\widehat{P}H, N^\infty : \text{Example} \Rightarrow (c = -1, e = 0, u = 1/4)$$

$$\text{(if } \widetilde{L} > 0\text{)}.$$

(b) *The case $\widetilde{M} = 0$.* Then we have $c = -2u$ and we obtain

$$C_2 = ex^3, \quad \mathcal{B}_3 = -288u^2(-1 + 2u)(1 + 4u)x^2, \quad W_{11} = -192u^4(1 + 2u)x^4.$$

(b.1) *The subcase $C_2 \neq 0$.* Due to $\mu_2 > 0$ we have $u > -1/2$ and this implies $W_{11} \neq 0$, i.e. the node is generic. So since $\widetilde{K} \neq 0$, $\mu_2 > 0$ and $K_2 > 0$ according to Lemma 6.1 we arrive at the following two global configurations of singularities:

$$s, n; \binom{2}{3} H\widehat{P}E - \widehat{P}\widehat{P}\widehat{P} : \text{Example} \Rightarrow (c = -2, e = 1, u = 1) \quad \text{(if } \mathcal{B}_3 \neq 0\text{);}$$

$$s, n; \binom{2}{3} H\widehat{P}E - \widehat{P}\widehat{P}\widehat{P} : \text{Example} \Rightarrow (c = -1, e = 1, u = 1/2) \quad \text{(if } \mathcal{B}_3 = 0\text{)}.$$

(b.2) *The subcase $C_2 = 0$.* Then we have $c + 2u = e = 0$ and as the node is generic, considering Lemma 6.1 we obtain the configurations

$$s, n; [\infty; N] : \text{Example} \Rightarrow (c = -2, e = 0, u = 1) \quad \text{(if } \mathcal{B}_3 \neq 0\text{);}$$

$$s, n; [\infty; N] : \text{Example} \Rightarrow (c = -1, e = 0, u = 1/2) \quad \text{(if } \mathcal{B}_3 = 0\text{)}.$$

6.2.2. *Systems with $\widetilde{K} = 0$.* Since $\widetilde{K}(\tilde{a}, x, y) = \text{Jacob}(p_2(\tilde{a}, x, y), q_2(\tilde{a}, x, y))$ (see Section 5) the condition $\widetilde{K} = 0$ means that the homogeneous quadratic parts of generic quadratic systems are proportional, say $q_2 = \lambda p_2$. Therefore clearly the transformation $x_1 = x, y_1 = -\lambda x + y$ leads to quadratic systems, of which the second equation is linear. Applying a translation (as these systems must have two finite real distinct singularities) we get the systems

$$\dot{x} = cx + dy + gx^2 + 2hxy + ky^2, \quad \dot{y} = ex + fy,$$

for which we calculate

$$U = \alpha^2(ex + fy)^2(gx^2 + 2hxy + ky^2)^2, \quad \mu_2 = \beta(gx^2 + 2hxy + ky^2),$$

where $\alpha = cf - de$ and $\beta = f^2g - 2efh + e^2k$. These systems possess the singularities $M_1(0, 0)$ and $M_2(-f\alpha/\beta, e\alpha/\beta)$ which are distinct due to $\mathbf{U} > 0$ and $\mu_2 \neq 0$. We observe that the condition $e = 0$ implies the existence of the invariant line $y = 0$ for these systems. So we consider two cases: $e \neq 0$ and $e = 0$.

In the first case we apply the transformation $x_1 = ex + fy$, $y_1 = \beta y/(e\alpha)$ and $t_1 = \beta t/(e\alpha)$ which places the point M_2 at the point $(0, 1)$. This leads to the family of systems (we keep the old variables)

$$\dot{x} = cx + dy + gx^2 + 2hxy - dy^2, \quad \dot{y} = x. \quad (6.29)$$

If $e = 0$ then $cfg \neq 0$ (as $\alpha\beta \neq 0$ and after the rescaling $(x, y, t) \mapsto (-cx/g, y, t/f)$ (which replaces $M_2(-c/g, 0)$ to the point $(1, 0)$) we arrive at the family of systems

$$\dot{x} = cx + dy - cx^2 + 2hxy + ky^2, \quad \dot{y} = y. \quad (6.30)$$

In what follows we consider each one of the families of systems we obtained.

A. Systems (6.29). We observe that the Jacobian matrices for the singularities $M_1(0, 0)$ and $M_2(0, 1)$ of these systems are respectively $\begin{pmatrix} c & d \\ 1 & 0 \end{pmatrix}$ and $\begin{pmatrix} c+2h & -d \\ 1 & 0 \end{pmatrix}$. So the next remark becomes obvious.

Remark 6.11. The family of systems (6.29) could not have a finite star node.

For systems (6.29) we calculate

$$\begin{aligned} \mu_0 = \mu_1 = \kappa = \tilde{K} = 0, \quad \eta = 4g^2(dg + h^2), \quad \mu_2 = -d(gx^2 + 2hxy - dy^2), \\ \theta_2 = dg + h^2, \quad \mathbf{U} = d^2x^2(gx^2 + 2hxy - dy^2)^2, \quad G_8 = 2dg(dg + h^2), \\ W_4 = 16d^2g^2(dg + h^2)^2(c^2 + 4d)(c^2 - 4d + 4ch + 4h^2) = 16d^2g^2(dg + h^2)^2\tau_1\tau_2, \\ \mathbf{D} = -192d^4(dg + h^2), \quad \tilde{L} = 8g(gx^2 + 2hxy - dy^2), \\ \mathcal{F}_1 = 2d(cg + h + gh), \quad \mathcal{T}_4 = 4cdg(c + 2h)(dg + h^2). \end{aligned} \quad (6.31)$$

Remark 6.12. The condition $W_4 \neq 0$ implies $G_8\mathbf{D}\theta_2\eta \neq 0$ for systems (6.29).

The case $W_4 < 0$. Then by the above remark we have $G_8\mathbf{D} \neq 0$ and due to $\tilde{K} = 0$, according to [5] (see Table 1, lines 157,162) we have a saddle and either a focus or a center.

The subcase $\mathcal{T}_4 \neq 0$. By [33] we have a strong saddle and a strong focus. On the other hand as by Remark 6.12 the condition $\eta\theta_2 \neq 0$ holds, considering Lemma 6.1 we obtain the following three global configurations of singularities

$$s, f; N^d, \begin{pmatrix} 1 \\ 1 \end{pmatrix} \odot, \begin{pmatrix} 1 \\ 1 \end{pmatrix} \odot : \text{Example} \Rightarrow (c = 1, d = -2, g = 1, h = 1)$$

(if $\eta < 0$);

$$s, f; \overline{\begin{pmatrix} 1 \\ 1 \end{pmatrix}} SN, \overline{\begin{pmatrix} 1 \\ 1 \end{pmatrix}} SN, N^d : \text{Example} \Rightarrow (c = 1, d = -2, g = -1, h = 1)$$

(if $\eta > 0, \mu_2\tilde{L} < 0$);

$$s, f; \overline{\begin{pmatrix} 1 \\ 1 \end{pmatrix}} SN, \overline{\begin{pmatrix} 1 \\ 1 \end{pmatrix}} NS, N^d : \text{Example} \Rightarrow (c = 1, d = 3, g = -1/4, h = 1)$$

(if $\eta > 0, \mu_2\tilde{L} > 0$).

The subcase $\mathcal{T}_4 = 0$. Then one of the finite singularities is weak and by Remark 6.4 without loss of generality we may assume $\rho_1 = c = 0$, i.e. this weak singularity is $M_1(0, 0)$. In this case for systems (6.29) we calculate:

$$\begin{aligned} \mathcal{T}_3 &= 8dgh(dg + h^2), \quad \mathcal{F} = gh(dg + h^2), \quad \mathcal{F}_1 = 2dh(1 + g), \\ \mathcal{F}_2 = \mathcal{F}_3 &= 0, \quad W_4 = -256d^3g^2(d - h^2)(dg + h^2)^2. \end{aligned} \quad (6.32)$$

(a) *The possibility $\mathcal{T}_3\mathcal{F} < 0$.* According to [33] the systems possess a weak focus, the order of which is determined by the invariant polynomial \mathcal{F}_1 .

(a.1) *The case $\mathcal{F}_1 \neq 0$.* Then we have a first order weak focus and considering Lemma 6.1 and the conditions $\eta\theta_2 \neq 0$ and $\kappa = 0$ we obtain the following three global configurations of singularities:

$$s, f^{(1)}; N^d, \begin{pmatrix} 1 \\ 1 \end{pmatrix} \odot, \begin{pmatrix} 1 \\ 1 \end{pmatrix} \odot : \text{Example} \Rightarrow (c = 0, d = -1, g = 2, h = 1) \\ (\text{if } \eta < 0);$$

$$s, f^{(1)}; \overline{\begin{pmatrix} 1 \\ 1 \end{pmatrix}} SN, \overline{\begin{pmatrix} 1 \\ 1 \end{pmatrix}} SN, N^d : \text{Example} \Rightarrow (c = 0, d = -1, g = -2, h = 1) \\ (\text{if } \eta > 0, \mu_2\tilde{L} < 0);$$

$$s, f^{(1)}; \overline{\begin{pmatrix} 1 \\ 1 \end{pmatrix}} SN, \overline{\begin{pmatrix} 1 \\ 1 \end{pmatrix}} NS, N^d : \text{Example} \Rightarrow (c = 0, d = -1, g = 1/2, h = 1) \\ (\text{if } \eta > 0, \mu_2\tilde{L} > 0).$$

(a.2) *The case $\mathcal{F}_1 = 0$.* Then by (6.32) due to $\mathcal{T}_3 \neq 0$ we get $g = -1$ and then we have

$$\begin{aligned} \mu_2\tilde{L} &= 8d(x^2 - 2hxy + dy^2)^2, \quad \mathcal{T}_3\mathcal{F} = 8dh^2(d - h^2)^2, \\ \eta &= 4(h^2 - d), \quad W_4 = 256d^3(h^2 - d)^3. \end{aligned}$$

So we arrive at the following remark.

Remark 6.13. If $\mathcal{T}_4 = 0$ and $\mathcal{T}_3 \neq 0$ then the condition $\mathcal{F}_1 = 0$ implies $\text{sign}(\mathcal{T}_3\mathcal{F}) = \text{sign}(\mu_2\tilde{L}) = \text{sign}(\eta W_4)$.

Since by (6.32) we have $\mathcal{F}_2 = \mathcal{F}_3 = 0$, according to [33] systems (6.29) possess a center. By the above remark the conditions $\mathcal{T}_3\mathcal{F} < 0$ and $W_4 < 0$ imply $\mu_2\tilde{L} < 0$ and $\eta > 0$. So considering Lemma 6.1 we obtain the configuration

$$s, c; \overline{\begin{pmatrix} 1 \\ 1 \end{pmatrix}} SN, \overline{\begin{pmatrix} 1 \\ 1 \end{pmatrix}} SN, N^d : \text{Example} \Rightarrow (c = 0, d = -2, g = -1, h = 1).$$

(b) *The possibility $\mathcal{T}_3\mathcal{F} > 0$.* In this case by [33] the systems possess a weak saddle.

(b.1) *The case $\mathcal{F}_1 \neq 0$.* Then we have a first order weak saddle and considering Lemma 6.1 and the conditions $\eta\theta_2 \neq 0$ and $\kappa = 0$ we obtain the following three global configurations of singularities:

$$s^{(1)}, f; N^d, \begin{pmatrix} 1 \\ 1 \end{pmatrix} \odot, \begin{pmatrix} 1 \\ 1 \end{pmatrix} \odot : \text{Example} \Rightarrow (c = 0, d = 2, g = -2, h = 1) \\ (\text{if } \eta < 0);$$

$$s^{(1)}, f; \overline{\begin{pmatrix} 1 \\ 1 \end{pmatrix}} SN, \overline{\begin{pmatrix} 1 \\ 1 \end{pmatrix}} SN, N^d : \text{Example} \Rightarrow (c = 0, d = 2, g = 1, h = 1)$$

$$(\text{if } \eta > 0, \mu_2 \tilde{L} < 0);$$

$$s^{(1)}, f; \overline{\begin{pmatrix} 1 \\ 1 \end{pmatrix}} SN, \overline{\begin{pmatrix} 1 \\ 1 \end{pmatrix}} NS, N^d : \text{Example} \Rightarrow (c = 0, d = 2, g = -1/3, h = 1)$$

$$(\text{if } \eta > 0, \mu_2 \tilde{L} > 0).$$

(b.2) *The case $\mathcal{F}_1 = 0$.* Then the saddle is integrable. On the other hand by Remark 6.13 the condition $W_4 < 0$ implies $\eta < 0$ and this leads to the configuration

$$s, f; N^d, \begin{pmatrix} 1 \\ 1 \end{pmatrix} \odot, \begin{pmatrix} 1 \\ 1 \end{pmatrix} \odot : \text{Example} \Rightarrow (c = 0, d = 2, g = -1, h = 1).$$

(c) *The possibility $\mathcal{T}_3 = 0$.* By (6.32) due to $W_4 \neq 0$ the condition $\mathcal{T}_3 = 0$ implies $h = 0$ and then we obtain

$$\mathcal{T}_4 = \mathcal{T}_3 = \mathcal{F}_1 = 0, \quad \mathcal{T}_2 = 4d^2g^2, \quad \mathcal{B} = -2d^2g^4,$$

$$W_4 = -256d^6g^4, \quad \eta = 4dg^3, \quad \mu_2 \tilde{L} = -8dg(gx^2 - dy^2)^2.$$

Remark 6.14. If $W_4 \neq 0$ then the condition $\mathcal{T}_4 = \mathcal{T}_3 = 0$ implies $W_4 < 0$.

The condition $W_4 \neq 0$ implies $\mathcal{B} < 0$ and $\mathcal{T}_2 > 0$. Therefore by [33] we have a center and an integrable saddle. As the condition $\eta > 0$ implies $\mu_2 \tilde{L} < 0$, taking into consideration Lemma 6.1 we get following two configurations:

$$s, c; N^d, \begin{pmatrix} 1 \\ 1 \end{pmatrix} \odot, \begin{pmatrix} 1 \\ 1 \end{pmatrix} \odot : \text{Example} \Rightarrow (c = 0, d = 1, g = -1, h = 0) \quad (\text{if } \eta < 0);$$

$$s, c; \overline{\begin{pmatrix} 1 \\ 1 \end{pmatrix}} SN, \overline{\begin{pmatrix} 1 \\ 1 \end{pmatrix}} SN, N^d : \text{Example} \Rightarrow (c = 0, d = 1, g = 1, h = 0) \quad (\text{if } \eta > 0).$$

The case $W_4 > 0$. Since $\tilde{K} = 0$ and $G_8 \mathbf{D} \neq 0$ (see Remark 6.12), according to [5] (see Table 1, line 151) systems (6.29) possess a saddle and a node.

The subcase $\mathcal{T}_4 \neq 0$. Then by [33] the saddle is strong and as $W_4 \neq 0$ the node is generic and $\theta_2 \neq 0$. Therefore considering Lemma 6.1 we obtain the following three global configurations of singularities

$$s, n; N^d, \begin{pmatrix} 1 \\ 1 \end{pmatrix} \odot, \begin{pmatrix} 1 \\ 1 \end{pmatrix} \odot : \text{Example} \Rightarrow (c = 1, d = 1/2, g = -3, h = 1)$$

$$(\text{if } \eta < 0);$$

$$s, n; \overline{\begin{pmatrix} 1 \\ 1 \end{pmatrix}} SN, \overline{\begin{pmatrix} 1 \\ 1 \end{pmatrix}} SN, N^d : \text{Example} \Rightarrow (c = 1, d = 1/2, g = 1, h = 1)$$

$$(\text{if } \eta > 0, \mu_2 \tilde{L} < 0);$$

$$s, n; \overline{\begin{pmatrix} 1 \\ 1 \end{pmatrix}} SN, \overline{\begin{pmatrix} 1 \\ 1 \end{pmatrix}} NS, N^d : \text{Example} \Rightarrow (c = 1, d = 1/2, g = -1, h = 1)$$

$$(\text{if } \eta > 0, \mu_2 \tilde{L} > 0).$$

The subcase $\mathcal{T}_4 = 0$. Then the saddle is weak and by Remark 6.4 without loss of generality we may assume that this saddle is located at $M_1(0, 0)$, i.e. $c = 0$ and we consider the relations (6.32).

We observe that by Remark 6.14 the condition $W_4 > 0$ implies $\mathcal{T}_3 \neq 0$.

(a) *The possibility $\mathcal{F}_1 \neq 0$.* In this case by [33] the weak saddle is of order one and considering Lemma 6.1 we arrive at the following three global configurations of singularities:

$$s^{(1)}, n; N^d, \begin{pmatrix} 1 \\ 1 \end{pmatrix} \odot, \begin{pmatrix} 1 \\ 1 \end{pmatrix} \odot : \text{Example} \Rightarrow (c = 0, d = 1/2, g = -3, h = 1) \\ (\text{if } \eta < 0);$$

$$s^{(1)}, n; \overline{\begin{pmatrix} 1 \\ 1 \end{pmatrix}} SN, \overline{\begin{pmatrix} 1 \\ 1 \end{pmatrix}} SN, N^d : \text{Example} \Rightarrow (c = 0, d = 1/2, g = 1, h = 1) \\ (\text{if } \eta > 0, \mu_2 \tilde{L} < 0);$$

$$s^{(1)}, n; \overline{\begin{pmatrix} 1 \\ 1 \end{pmatrix}} SN, \overline{\begin{pmatrix} 1 \\ 1 \end{pmatrix}} NS, N^d : \text{Example} \Rightarrow (c = 0, d = 1/2, g = -1/2, h = 1) \\ (\text{if } \eta > 0, \mu_2 \tilde{L} > 0).$$

(b) *The possibility $\mathcal{F}_1 = 0$.* As $\mathcal{F}_2 = \mathcal{F}_3 = 0$ according to [33] systems (6.29) possess an integrable saddle. On the other hand by Remark 6.13 the condition $W_4 > 0$ implies $\eta > 0$ and this leads to the configuration

$$s, n; \overline{\begin{pmatrix} 1 \\ 1 \end{pmatrix}} SN, \overline{\begin{pmatrix} 1 \\ 1 \end{pmatrix}} NS, N^d : \text{Example} \Rightarrow (c = 0, d = 1/2, g = -1, h = 1).$$

The case $W_4 = 0$. Taking into account (6.31) we consider two possibilities: $\eta \neq 0$ and $\eta = 0$.

The subcase $\eta \neq 0$. Then due to $\mu_2 \neq 0$ the condition $W_4 = 0$ implies $\tau_1 \tau_2 = (c^2 + 4d)(c^2 - 4d + 4ch + 4h^2) = 0$, i.e. one of the singularities is a node with coinciding eigenvalues. Moreover by Remark 6.11 we have a node with one direction. According to Remark 6.4 we may assume that the singularity $M_1(0, 0)$ is such a node and this implies $\tau_1 = c^2 + 4d = 0$, i.e. $d = -c^2/4 \neq 0$. So we may assume $c = 1$ due to the rescaling $(x, y, t) \mapsto (cx, y, t/c)$ and this leads to the family of systems

$$\dot{x} = x - y/4 + gx^2 + 2hxy + y^2/4, \quad \dot{y} = x. \quad (6.33)$$

for which we calculate

$$\mu_2 \tilde{L} = 2g(4gx^2 + 8hxy + y^2)^2/8, \quad \mathcal{T}_4 = g(1 + 2h)(g - 4h^2)/4, \\ \theta_2 = (4h^2 - g)/4, \quad \eta = g^2(4h^2 - g).$$

(1) *The possibility $\mathcal{T}_4 \neq 0$.* Then by [33] we have a strong saddle. We observe that the condition $\eta \neq 0$ implies $\theta_2 \neq 0$ and considering Lemma 6.1 we obtain the following three global configurations of singularities:

$$s, n^d; N^d, \begin{pmatrix} 1 \\ 1 \end{pmatrix} \odot, \begin{pmatrix} 1 \\ 1 \end{pmatrix} \odot : \text{Example} \Rightarrow (c = 1, d = -1/4, g = 1, h = 0) \\ (\text{if } \eta < 0);$$

$$s, n^d; \overline{\begin{pmatrix} 1 \\ 1 \end{pmatrix}} SN, \overline{\begin{pmatrix} 1 \\ 1 \end{pmatrix}} SN, N^d : \text{Example} \Rightarrow (c = 1, d = -1/4, g = -1, h = 0)$$

$$(\text{if } \eta > 0, \mu_2 \tilde{L} < 0);$$

$$s, n^d; \overline{\begin{pmatrix} 1 \\ 1 \end{pmatrix}} SN, \overline{\begin{pmatrix} 1 \\ 1 \end{pmatrix}} NS, N^d : \text{Example} \Rightarrow (c = 1, d = -1/4, g = 1, h = 1)$$

$$(\text{if } \eta > 0, \mu_2 \tilde{L} > 0).$$

(2) *The possibility* $\mathcal{T}_4 = 0$. Then the saddle M_2 is weak. As $\eta \neq 0$ we get $h = -1/2$ and then

$$\eta = g^2(1 - g), \quad \mathcal{F}_1 = (1 - g)/4, \quad \theta_2 = (1 - g)/4.$$

So due to $\eta \neq 0$ we have $\theta_2 \mathcal{F}_1 \neq 0$, i.e. the weak saddle is of order one. Therefore we get the following three configurations of singularities:

$$s^{(1)}, n^d; N^d, \begin{pmatrix} 1 \\ 1 \end{pmatrix} \odot, \begin{pmatrix} 1 \\ 1 \end{pmatrix} \odot : \text{Example} \Rightarrow (c = 1, d = -1/4, g = 2, h = -1/2)$$

$$(\text{if } \eta < 0);$$

$$s^{(1)}, n^d; \overline{\begin{pmatrix} 1 \\ 1 \end{pmatrix}} SN, \overline{\begin{pmatrix} 1 \\ 1 \end{pmatrix}} SN, N^d : \text{Example} \Rightarrow (c = 1, d = -1/4, g = -1,$$

$$h = -1/2) \quad (\text{if } \eta > 0, \mu_2 \tilde{L} < 0);$$

$$s^{(1)}, n^d; \overline{\begin{pmatrix} 1 \\ 1 \end{pmatrix}} SN, \overline{\begin{pmatrix} 1 \\ 1 \end{pmatrix}} NS, N^d : \text{Example} \Rightarrow (c = 1, d = -1/4, g = 1/2,$$

$$h = -1/2) \quad (\text{if } \eta > 0, \mu_2 \tilde{L} > 0).$$

The subcase $\eta = 0$. Considering (6.31) we have $g(dg + h^2) = 0$ and we consider two possibilities: $\tilde{L} \neq 0$ (then $g \neq 0$) and $\tilde{L} = 0$ (then $g = 0$).

(1) *The possibility* $\tilde{L} \neq 0$. In this case $g \neq 0$ and as $d \neq 0$ we obtain $g = -h^2/d \neq 0$. Hence we may assume $h = 1$ due to the rescaling $(x, y, t) \mapsto (hx, y, t/h)$ (and by introducing new parameters $\tilde{c} = c/h, \tilde{d} = d/h^2$). So we arrive at the family of systems (we keep the old parameters)

$$\dot{x} = cx + dy - x^2/d + 2xy - dy^2, \quad \dot{y} = x. \quad (6.34)$$

for which we calculate

$$\kappa = \eta = \tilde{K} = \mathbf{D} = 0, \quad \kappa_1 = -32(1 + c - d)/d,$$

$$\theta_5 = 96(1 + c - d)(x - dy)^3/d^2, \quad \tilde{M} = -8(x - dy)^2/d^2 = -\tilde{L},$$

$$\mu_2 = (x - dy)^2, \quad G_3 = -2(1 + c - d),$$

$$W_8 = 2^{12}3^3(1 + c - d)^2(c^2 + 4d)[(c + 2)^2 - 4d] = 2^{12}3^3(1 + c - d)^2\tau_1\tau_2,$$

$$\mathcal{T}_i = 0, \quad i = 1, 2, 3, 4, \quad \sigma = c - 2x/d + 2y, \quad \mathcal{F}_1 = -2(1 + c - d), \quad \mathcal{H} = 0,$$

$$\mathcal{B}_1 = -2c(2 + c)(1 + c - d) = -2(1 + c - d)\rho_1\rho_2, \quad \mathcal{B}_2 = 4(1 + c)(1 + c - d)^2/d. \quad (6.35)$$

Remark 6.15. The condition $W_8 \neq 0$ implies $G_3\kappa_1\theta_5\mathcal{F}_1 \neq 0$ for systems (6.34). Moreover in this case the condition $\mathcal{B}_1 = 0$ is equivalent to $\rho_1\rho_2 = 0$.

Since $\widetilde{K} = \mathbf{D} = 0$ according to [5] the types of the finite singularities are governed by the invariant polynomials W_8, W_9, G_3 and D_2 .

(a) *The case $W_8 < 0$.* Then by Remark 6.15 we have $G_3 \neq 0$ and by [5] (see Table 1, line 159) systems (6.34) possess a saddle and a focus.

(a.1) *The subcase $\mathcal{B}_1 \neq 0$.* Then $\rho_1\rho_2 \neq 0$ and we do not have weak singularities. On the other hand as $\widetilde{M}\widetilde{L}\kappa_1\theta_5 \neq 0$, considering Lemma 6.1, we obtain the global configuration of singularities

$$s, f; \widehat{\binom{2}{2}}\widehat{P}_\lambda\widehat{P}H_\lambda - H, N^d : \text{Example} \Rightarrow (c = 1, d = -1, g = 1, h = 1).$$

(a.2) *The subcase $\mathcal{B}_1 = 0$.* Then one of the finite singularities is weak and by Remark 6.4 without loss of generality we may assume such a point to be $M_1(0, 0)$, i.e. for systems (6.34) the condition $\rho_1 = c = 0$ holds. So we have

$$\mathcal{B}_1 = 0, \quad \mathcal{B}_2 = 4(1 - d)^2/d, \quad W_8 = 2^{16}3^3d(1 - d)^3. \tag{6.36}$$

Therefore the condition $W_8 < 0$ implies $\mathcal{B}_2 \neq 0$ and by [33] the type of weak singularity (which is of order one due to $\mathcal{F}_1 \neq 0$) depends of the sign of \mathcal{B}_2 . Thus considering Lemma 6.1 we get the following two global configurations of singularities:

$$s, f^{(1)}; \widehat{\binom{2}{2}}\widehat{P}_\lambda\widehat{P}H_\lambda - H, N^d : \text{Example} \Rightarrow (c = 0, d = -1, g = 1, h = 1) \\ \text{(if } \mathcal{B}_2 < 0);$$

$$s^{(1)}, f; \widehat{\binom{2}{2}}\widehat{P}_\lambda\widehat{P}H_\lambda - H, N^d : \text{Example} \Rightarrow (c = 0, d = 2, g = -1/2, h = 1) \\ \text{(if } \mathcal{B}_2 > 0).$$

(b) *The case $W_8 > 0$.* Then by [5, Table 1, line 153], systems (6.34) possess a saddle and a node which is generic (due to $W_8 \neq 0$).

(b.1) *The subcase $\mathcal{B}_1 \neq 0$.* Then the saddle is strong and considering Remark 6.15 and Lemma 6.1 we arrive at the configuration

$$s, n; \widehat{\binom{2}{2}}\widehat{P}_\lambda\widehat{P}H_\lambda - H, N^d : \text{Example} \Rightarrow (c = 1, d = 1, g = -1, h = 1).$$

(b.2) *The subcase $\mathcal{B}_1 = 0$.* It was mentioned earlier that in this case we may assume $c = 0$, i.e. the weak saddle of the first order (as $\mathcal{F}_1 \neq 0$) is located at the origin of coordinates. Considering Remark 6.15 and Lemma 6.1 we obtain the configuration

$$s^{(1)}, n; \widehat{\binom{2}{2}}\widehat{P}_\lambda\widehat{P}H_\lambda - H, N^d : \text{Example} \Rightarrow (c = 0, d = 1/2, g = -2, h = 1).$$

(c) *The case $W_8 = 0$.* Then $(1 + c - d)\tau_1\tau_2 = 0$ and considering (6.35) we have to distinguish two subcases given by the invariant polynomial κ_1 .

(c.1) *The subcase $\kappa_1 \neq 0$.* Then $(1 + c - d) \neq 0$ and the condition $W_8 = 0$ gives $\tau_1\tau_2 = 0$. Therefore we have a node with coinciding eigenvalues and by Remark 6.4 we may assume that this node is located at the origin of coordinates, i.e. the

condition $\tau_1 = c^2 + 4d = 0$ holds. We note that by Remark 6.11 this node could not be a star node. So we have $d = -c^2/4 \neq 0$ and we calculate

$$\mathcal{B}_1 = -c(2+c)^3/2, \quad \kappa_1 = 32(2+c)^2/c^2, \quad \theta_5 = -6(2+c)^2(4x+c^2y)^3/c^4.$$

The condition $\kappa_1 \neq 0$ implies $\mathcal{B}_1 \neq 0$ and by [33], the saddle is strong. On the other hand the condition $\kappa_1 \neq 0$ implies $\theta_5 \neq 0$ and considering Lemma 6.1 we arrive at the configuration

$$s, n^d; \begin{pmatrix} 2 \\ 2 \end{pmatrix} \widehat{P}_\lambda \widehat{P} H_\lambda - H, N^d : \text{Example} \Rightarrow (c = 1, d = -1/4, g = 4, h = 1).$$

(c.2) *The subcase* $\kappa_1 = 0$. Then by (6.35) we have $c = d - 1$ and for systems (6.34) we calculate

$$\begin{aligned} \mu_0 = \mu_1 = \widetilde{K} = \eta = \mathbf{D} = \kappa = \kappa_1 = 0, \quad \widetilde{M} = -8(x-dy)^2/d^2 = \mathcal{G}, \\ \mu_2 = (x-dy)^2, \quad K_2 = 96(x-dy)^2/d^2, \quad \theta_6 = 8(x-dy)^4/d^2, \\ G_3 = 0, \quad D_2 = 2(x-dy)/d, \quad \mathbf{U} = x^2(x-dy)^4, \\ \mathcal{T}_i = 0, \quad i = 1, 2, 3, 4, \quad \sigma = d - 1 - 2x/d + 2y, \quad \mathcal{F}_1 = \mathcal{H} = 0, \\ \mathcal{B} = \mathcal{B}_1 = \mathcal{B}_2 = 0, \quad \mathcal{B}_3 = 72(d-1)(1+d)(x-dy)/d^2. \end{aligned} \quad (6.37)$$

Since $\mathbf{D} = \widetilde{K} = G_3 = 0$ and $D_2 \neq 0$, according to [5] (see Table 1, line 154) we have a saddle and a node. Considering (6.37), by [33] (see the Main Theorem, the statement $(e_3)[\delta]$) the saddle will be weak (more precisely it will be an integrable one) if and only if $\mathcal{B}_3 = 0$. Moreover for the singular points $M_1(0,0)$ and $M_2(0,1)$ we have, respectively

$$\rho_1 = d - 1, \quad \tau_1 = (d + 1)^2, \quad \rho_2 = d + 1, \quad \tau_2 = (d - 1)^2.$$

Therefore, we observe that if one of the singular points is a weak saddle, the second one becomes a node with coinciding eigenvalues, which by Remark 6.11 is a node n^d .

Since $K_2 > 0$ and $\theta_6 \neq 0$, considering Lemma 6.1, we obtain the following two global configurations of singularities:

$$s, n; \begin{pmatrix} 2 \\ 2 \end{pmatrix} \widehat{P} \widehat{P} H - \widehat{P} \widehat{P} H, N^d : \text{Example} \Rightarrow (c = 1, d = 2, g = -1/2, h = 1) \\ \text{(if } \mathcal{B}_3 \neq 0);$$

$$s, n^d; \begin{pmatrix} 2 \\ 2 \end{pmatrix} \widehat{P} \widehat{P} H - \widehat{P} \widehat{P} H, N^d : \text{Example} \Rightarrow (c = 0, d = 1, g = -1, h = 1) \\ \text{(if } \mathcal{B}_3 = 0).$$

(2) *The possibility* $\widetilde{L} = 0$. Then $g = 0$ and we obtain the family of systems

$$\dot{x} = cx + dy + 2hxy - dy^2, \quad \dot{y} = x. \quad (6.38)$$

for which we calculate

$$\begin{aligned} \mu_0 = \mu_1 = \widetilde{K} = \kappa = \eta = G_8 = 0, \quad \mu_2 = dy(-2hx + dy), \quad \mathbf{D} = -192d^4h^2, \\ \mathbf{U} = d^2x^2y^2(2hx - dy)^2, \quad W_7 = 12d^2h^6(c^2 + 4d)[(c + 2h)^2 - 4d] = 12d^2h^6\tau_1\tau_2, \\ \mathcal{T}_i = 0, \quad i = 1, 2, 3, 4, \quad \sigma = c + 2hy, \quad \mathcal{F}_1 = 2dh, \quad \mathcal{H} = 0, \\ \mathcal{B}_1 = 2cdh(c + 2h) = 2dh\rho_1\rho_2, \quad \mathcal{B}_2 = 4dh^3(c + h), \quad \widetilde{M} = -32h^2y^2. \end{aligned} \quad (6.39)$$

For the singular points $\widetilde{M}_1(0,0)$ and $\widetilde{M}_2(0,1)$ of the above systems we have $\Delta_2 = d = -\Delta_1$ and hence these systems possess a saddle and an anti-saddle.

(a) *The case $W_7 < 0$.* Then we have a saddle and a focus or a center and considering (6.39) we observe that the condition $\mathcal{B}_1 = 0$ is equivalent to $\rho_1\rho_2 = 0$.

(a.1) *The subcase $\mathcal{B}_1 \neq 0$.* Then both singularities are strong and considering Lemma 6.1 we arrive at the configuration

$$s, f; \left(\widehat{\begin{matrix} 1 \\ 2 \end{matrix}}\right) \widehat{P}_\lambda E \widehat{P}_\lambda - H, \left(\overline{\begin{matrix} 1 \\ 1 \end{matrix}}\right) SN : \text{Example} \Rightarrow (c = 1, d = -1, g = 0, h = 1).$$

(a.2) *The subcase $\mathcal{B}_1 = 0$.* Then one of the finite singularities is weak and by Remark 6.4 without loss of generality we may assume such a point is $\widetilde{M}_1(0,0)$, i.e. for systems (6.38) the condition $\rho_1 = c = 0$ holds. In this case we calculate

$$\mathcal{B}_1 = 0, \quad \mathcal{B}_2 = 4dh^4, \quad \mathcal{F}_1 = 2dh, \quad W_7 = -192d^3h^6(d - h^2). \quad (6.40)$$

Therefore the condition $W_7 \neq 0$ implies $\mathcal{F}_1\mathcal{B}_2 \neq 0$ and by [33] the type of the weak singularity (which is of order one due to $\mathcal{F}_1 \neq 0$) depends on the sign of \mathcal{B}_2 . Thus considering Lemma 6.1 we obtain the following two global configurations of singularities:

$$s, f^{(1)}; \left(\widehat{\begin{matrix} 1 \\ 2 \end{matrix}}\right) \widehat{P}_\lambda E \widehat{P}_\lambda - H, \left(\overline{\begin{matrix} 1 \\ 1 \end{matrix}}\right) SN : \text{Example} \Rightarrow (c = 0, d = -1, g = 0, h = 1) \\ \text{(if } \mathcal{B}_2 < 0\text{);}$$

$$s^{(1)}, f; \left(\widehat{\begin{matrix} 1 \\ 2 \end{matrix}}\right) \widehat{P}_\lambda E \widehat{P}_\lambda - H, \left(\overline{\begin{matrix} 1 \\ 1 \end{matrix}}\right) SN : \text{Example} \Rightarrow (c = 0, d = 2, g = 0, h = 1) \\ \text{(if } \mathcal{B}_2 > 0\text{)}.$$

(b) *The case $W_7 > 0$.* Then by [5, Table 1, line 152], systems (6.38) possess a saddle and a node which is generic (due to $W_7 \neq 0$).

Taking into account the fact that the saddle is weak if and only if $\mathcal{B}_1 = 0$ we get the following two global configurations of singularities:

$$s, n; \left(\widehat{\begin{matrix} 1 \\ 2 \end{matrix}}\right) \widehat{P}_\lambda E \widehat{P}_\lambda - H, \left(\overline{\begin{matrix} 1 \\ 1 \end{matrix}}\right) SN : \text{Example} \Rightarrow (c = 1, d = 1/2, g = 0, h = 1) \\ \text{(if } \mathcal{B}_1 \neq 0\text{);}$$

$$s^{(1)}, n; \left(\widehat{\begin{matrix} 1 \\ 2 \end{matrix}}\right) \widehat{P}_\lambda E \widehat{P}_\lambda - H, \left(\overline{\begin{matrix} 1 \\ 1 \end{matrix}}\right) SN : \text{Example} \Rightarrow (c = 0, d = 1/2, g = 0, h = 1) \\ \text{(if } \mathcal{B}_1 = 0\text{)}.$$

(c) *The case $W_7 = 0$.* Since $\mu_2 \neq 0$ by (6.39) we have $h\tau_1\tau_2 = 0$ and we consider two subcases: $\widetilde{M} \neq 0$ and $\widetilde{M} = 0$.

(c.1) *The subcase $\widetilde{M} \neq 0$.* Then $h \neq 0$ and we have a node with coinciding eigenvalues. By Remark 6.4 we may assume that this node is located at the origin of coordinates, i.e. we have $\tau_1 = c^2 + 4d = 0$. So we have a node n^d (see Remark 6.11) and setting $d = -c^2/4 \neq 0$ we may assume $c = 1$ due to the rescaling $(x, y, t) \mapsto (cx, y, t/c)$. This leads to the family of systems

$$\dot{x} = x - y/4 + 2hxy + y^2/4, \quad \dot{y} = x, \quad (6.41)$$

and we calculate

$$\begin{aligned}\sigma &= 1 + 2hy, & \mathcal{B}_1 &= -h(1 + 2h)/2, \\ \mathcal{B}_2 &= -h^3(1 + h), & \mathcal{F}_1 &= -h/2, & \widetilde{M} &= -32h^2y^2.\end{aligned}$$

Since $\widetilde{M} \neq 0$ we could have a weak saddle if and only if $h = -1/2$ and the weak saddle is of order one due to $\mathcal{F}_1 \neq 0$ (see [33], Main Theorem, the statement (e_1)). So considering Lemma 6.1 we get the following two global configurations of singularities

$$s, n^d; \begin{pmatrix} 1 \\ 2 \end{pmatrix} \widehat{P}_\lambda E \widehat{P}_\lambda - H, \begin{pmatrix} 1 \\ 1 \end{pmatrix} SN : \text{Example} \Rightarrow (c = 1, d = -1/4, g = 0, h = 1) \\ \text{(if } \mathcal{B}_1 \neq 0\text{);}$$

$$s^{(1)}, n^d; \begin{pmatrix} 1 \\ 2 \end{pmatrix} \widehat{P}_\lambda E \widehat{P}_\lambda - H, \begin{pmatrix} 1 \\ 1 \end{pmatrix} SN : \text{Example} \Rightarrow (c = 1, d = -1/4, g = 0, \\ h = -1/2) \text{ (if } \mathcal{B}_1 = 0\text{)}.$$

(c.2) *The subcase* $\widetilde{M} = 0$. Then $h = 0$ and we get the family of systems

$$\dot{x} = cx + dy - dy^2, \quad \dot{y} = x, \quad (6.42)$$

and we calculate

$$\begin{aligned}\widetilde{M} &= 0, & C_2 &= -dy^3, & \mu_2 &= d^2y^2, & W_9 &= 12(c^2 + 4d)(c^2 - 4d) = 12\tau_1\tau_2, \\ \mathcal{T}_i &= 0, & i &= 1, 2, 3, 4, & \sigma &= c = \rho_1 = \rho_2, & \Delta_2 &= d = -\Delta_1.\end{aligned} \quad (6.43)$$

So the above systems possess a saddle and an anti-saddle and clearly the type of the anti-saddle is governed by the invariant polynomial W_9 .

(α) *The possibility* $W_9 < 0$. In this case we have a saddle and a focus or a center and considering (6.43) we observe that we could have a weak singularity if and only if we have $\sigma = 0$. However in this case we get Hamiltonian systems possessing a center and an integrable saddle. As $C_2 \neq 0$ (due to $\mu_2 \neq 0$) considering Lemma 6.1 we obtain the following two global configurations of singularities:

$$s, f; \begin{pmatrix} 2 \\ 3 \end{pmatrix} \widehat{P}_\lambda \widehat{P} - \widehat{P}_\lambda \widehat{P} : \text{Example} \Rightarrow (c = 1, d = 1, g = 0, h = 0) \text{ (if } \sigma \neq 0\text{);}$$

$$s, c; \begin{pmatrix} 2 \\ 3 \end{pmatrix} \widehat{P}_\lambda \widehat{P} - \widehat{P}_\lambda \widehat{P} : \text{Example} \Rightarrow (c = 0, d = 1, g = 0, h = 0) \text{ (if } \sigma = 0\text{)}.$$

(β) *The possibility* $W_9 \geq 0$. Then we have a saddle and a node and in this case we have $\sigma \neq 0$, otherwise if $c = 0$ we get $W_9 = -192d^2 < 0$. So the saddle is strong and the node is generic if $W_9 > 0$ and it is a node with one direction (see Remark 6.11) if $W_9 = 0$. Therefore considering Lemma 6.1 we obtain the following two global configurations of singularities:

$$s, n; \begin{pmatrix} 2 \\ 3 \end{pmatrix} \widehat{P}_\lambda \widehat{P} - \widehat{P}_\lambda \widehat{P} : \text{Example} \Rightarrow (c = 3, d = 1, g = 0, h = 0) \text{ (if } W_9 > 0\text{);}$$

$$s, n^d; \begin{pmatrix} 2 \\ 3 \end{pmatrix} \widehat{P}_\lambda \widehat{P} - \widehat{P}_\lambda \widehat{P} : \text{Example} \Rightarrow (c = 2, d = 1, g = 0, h = 0) \text{ (if } W_9 = 0\text{)}.$$

As all the possibilities are investigated we have ended the examination of systems (6.29).

B. Systems (6.30). We consider systems (6.30), i.e. the systems of the form

$$\dot{x} = cx + dy - cx^2 + 2hxy + ky^2, \quad \dot{y} = y, \tag{6.44}$$

which possess the finite the singularities $M_1(0, 0)$ and $M_2(1, 0)$. We observe that the Jacobian matrices corresponding to these singular points are respectively $\begin{pmatrix} c & d \\ 0 & 1 \end{pmatrix}$

and $\begin{pmatrix} -c & d + 2h \\ 0 & 1 \end{pmatrix}$ and therefore we have

$$\rho_1 = c + 1, \quad \Delta_1 = c, \quad \tau_1 = (c - 1)^2; \quad \rho_2 = 1 - c, \quad \Delta_2 = -c, \quad \tau_2 = (c + 1)^2. \tag{6.45}$$

So obviously we have the next remark.

Remark 6.16. The family of systems (6.44) have a finite node and a finite saddle. The node has coinciding eigenvalues if and only if $(c - 1)(c + 1) = 0$ and in this case the systems simultaneously have a weak saddle. Moreover these systems have a star node if and only if either $c - 1 = d = 0$, or $c + 1 = d + h = 0$.

For systems (6.44) we calculate

$$\begin{aligned} \mu_0 = \mu_1 = \kappa = \tilde{K} = 0, \quad \eta = 4c^2(h^2 + ck), \quad \mu_2 = c(cx^2 - 2hxy - ky^2), \\ \theta_2 = 0, \quad \mathbf{U} = c^2y^2(cx^2 - 2hxy - ky^2)^2, \quad G_8 = -2c^2(h^2 + ck), \\ W_4 = 16c^4(c - 1)^2(c + 1)^2(h^2 + ck)^2, \tag{6.46} \\ \mathbf{D} = -192c^4(h^2 + ck), \quad \tilde{L} = 8c(cx^2 - 2hxy - ky^2), \\ \mathcal{F}_1 = -2c(cd - h + ch), \quad \mathcal{T}_4 = 4c^2(c + 1)(c - 1)(h^2 + ck). \end{aligned}$$

We observe that for systems (6.44) the following conditions hold

$$W_4 \geq 0, \quad \mu_2 \tilde{L} > 0, \quad \theta_2 = 0. \tag{6.47}$$

The case $W_4 \neq 0$. In this case by (6.47) we have $W_4 > 0$ and this implies $\eta \mathcal{T}_4 \neq 0$. Hence obviously the node is generic and the saddle is strong.

Considering (6.47) and Lemma 6.1 we obtain the following two global configurations of singularities

$$s, n; N^*, \begin{pmatrix} 1 \\ 1 \end{pmatrix} \odot, \begin{pmatrix} 1 \\ 1 \end{pmatrix} \odot : \text{Example} \Rightarrow (c = 2, d = 0, h = 1, k = -1) \text{ (if } \eta < 0\text{);}$$

$$s, n; \overline{\begin{pmatrix} 1 \\ 1 \end{pmatrix}} SN, \overline{\begin{pmatrix} 1 \\ 1 \end{pmatrix}} NS, N^* : \text{Example} \Rightarrow (c = 2, d = 0, h = 1, k = 1) \text{ (if } \eta > 0\text{).}$$

The case $W_4 = 0$. Taking into account (6.46), we consider two possibilities: $\eta \neq 0$ and $\eta = 0$.

The subcase $\eta \neq 0$. Then the condition $W_4 = 0$ implies $\tau_1 \tau_2 = (c - 1)^2(c + 1)^2 = 0$, i.e. one of singularities is a node with coinciding eigenvalues. According to Remark 6.4 we may assume that the singularity $M_1(0, 0)$ is such a node and this implies $\tau_1 = (c - 1)^2 = 0$, i.e. $c = 1$. Then we calculate

$$\mathcal{T}_4 = \mathcal{F}_2 = \mathcal{F}_3 = 0, \quad \mathcal{T}_3 \mathcal{F} = 8(h^2 + k)^2, \quad \mathcal{F}_1 = -2d, \quad \eta = 4(h^2 + k).$$

We observe that the condition $\eta \neq 0$ implies $\mathcal{T}_3 \mathcal{F} > 0$ and by [33] we have a weak saddle of order one if $\mathcal{F}_1 \neq 0$ and an integrable saddle if $\mathcal{F}_1 = 0$. On the other hand by Remark 6.16 we have a node n^d if $\mathcal{F}_1 \neq 0$ and a star node if $\mathcal{F}_1 = 0$.

Thus considering (6.47) and Lemma 6.1 we obtain the following four global configurations of singularities:

$$s^{(1)}, n^d; N^*, \begin{pmatrix} 1 \\ 1 \end{pmatrix} \odot, \begin{pmatrix} 1 \\ 1 \end{pmatrix} \odot : \text{Example} \Rightarrow (c = 1, d = 1, h = 1, k = -2) \\ (\text{if } \eta < 0, \mathcal{F}_1 \neq 0);$$

$$s, n^*; N^*, \begin{pmatrix} 1 \\ 1 \end{pmatrix} \odot, \begin{pmatrix} 1 \\ 1 \end{pmatrix} \odot : \text{Example} \Rightarrow (c = 1, d = 0, h = 1, k = -2) \\ (\text{if } \eta < 0, \mathcal{F}_1 = 0);$$

$$s^{(1)}, n^d; \overline{\begin{pmatrix} 1 \\ 1 \end{pmatrix}} SN, \overline{\begin{pmatrix} 1 \\ 1 \end{pmatrix}} NS, N^* : \text{Example} \Rightarrow (c = 1, d = 1, h = 1, k = 0) \\ (\text{if } \eta > 0, \mathcal{F}_1 \neq 0);$$

$$s, n^*; \overline{\begin{pmatrix} 1 \\ 1 \end{pmatrix}} SN, \overline{\begin{pmatrix} 1 \\ 1 \end{pmatrix}} NS, N^* : \text{Example} \Rightarrow (c = 1, d = 0, h = 1, k = 0) \\ (\text{if } \eta > 0, \mathcal{F}_1 = 0).$$

The subcase $\eta = 0$. Considering (6.46) due to $\mu_2 \neq 0$ (i.e. $c \neq 0$) we obtain $k = -h^2/c \neq 0$ and this implies $W_4 = 0$. Then we may assume $h = 1$ due to the rescaling $(x, y, t) \mapsto (x, y/h, t)$. So we get the family of systems

$$\dot{x} = cx + dy - cx^2 + 2xy - y^2/c, \quad \dot{y} = y, \quad (6.48)$$

for which we calculate

$$\begin{aligned} \kappa = \eta = \tilde{K} = \mathbf{D} = \theta_5 = 0, \quad \kappa_1 = -32c(c-1+cd) = 16G_3, \\ \tilde{M} = -8(cx-y)^2 = -\tilde{L}, \quad \mu_2 = (cx-y)^2, \quad \sigma = 1+c-2cx+2y, \\ W_8 = 2^{12}3^3c^2(c-1)^2(1+c)^2(c-1+cd)^2, \quad \mathcal{H} = 0, \\ \mathcal{T}_i = 0, \quad i = 1, 2, 3, 4, \quad \mathcal{F}_1 = -2(c-1+cd), \quad \mathcal{B}_2 = 4c^2(c-1+cd)^2, \\ \mathcal{B}_1 = 2c(c-1+cd)(c+1)(c-1) = 2c(c-1+cd)\rho_1\rho_2. \end{aligned} \quad (6.49)$$

We note that by Remark 6.16 the above systems possess a node and a saddle.

(a) *The case $W_8 \neq 0$.* Then by (6.49) we have $W_8 > 0$ and this implies $\kappa_1 \mathcal{B}_1 \neq 0$. Hence obviously the node is generic and the saddle is strong. Since $\kappa_1 \tilde{M} \tilde{L} \neq 0$ and $\theta_5 = 0$ considering Lemma 6.1 we obtain the configuration

$$s, n; \widehat{\begin{pmatrix} 2 \\ 2 \end{pmatrix}} \tilde{P}_\lambda \tilde{P} H_\lambda - H, N^* : \text{Example} \Rightarrow (c = 2, d = 0, h = 1, k = -1/2).$$

(b) *The case $W_8 = 0$.* Then $(c-1)(1+c)(c-1+cd) = 0$ (as $c \neq 0$) and considering (6.49) we have to distinguish two subcases: $\kappa_1 \neq 0$ and $\kappa_1 = 0$.

(b.1) *The subcase $\kappa_1 \neq 0$.* Then $(c-1+cd) \neq 0$ and hence we get $(c-1)(1+c) = 0$. So one of the singularities is a node with coinciding eigenvalues and by Remark 6.4 we may assume that the singularity $M_1(0,0)$ is such a node, i.e. $c = 1$. Then we calculate

$$\mathcal{H} = \mathcal{B}_1 = 0, \quad \mathcal{F}_1 = -2d, \quad \mathcal{B}_2 = 4d^2, \quad \kappa_1 = -32d.$$

Therefore, the condition $\kappa_1 \neq 0$ implies $\mathcal{F}_1 \neq 0$ and $\mathcal{B}_2 > 0$. By [33] (see the Main Theorem, the statement (e_1)) and by Remark 6.16, systems (6.48) possess a weak saddle of order one and a node n^d .

Thus considering the condition $\theta_5 = 0$ by Lemma 6.1 we get the global configuration of singularities

$$s^{(1)}, n^d; \binom{2}{2} \widehat{P}_\lambda \widehat{P}H_\lambda - H, N^* : \text{Example} \Rightarrow (c = 1, d = 1, h = 1, k = -1).$$

(b.2) *The subcase $\kappa_1 = 0$.* Then due to $\mu_2 \neq 0$ (i.e. $c \neq 0$) by (6.49) we have $d = (1 - c)/c$. So for systems (6.48) we calculate

$$\begin{aligned} \widetilde{K} = \kappa_1 = \theta_6 = 0, \quad \widetilde{M} = -8(cx - y)^2 = \mathcal{G}, \quad K_2 = 96c^2(cx - y)^2, \\ \mu_2 = (cx - y)^2, \quad \sigma = 1 + c - 2cx + 2y, \quad \mathcal{F}_1 = \mathcal{H} = \mathcal{B} = \mathcal{B}_1 = \mathcal{B}_2 = 0, \quad (6.50) \\ \mathcal{B}_3 = -72(c - 1)(1 + c)(cx - y)^2 = -72\rho_1\rho_2(cx - y)^2. \end{aligned}$$

Considering (6.50) by [33] (see the Main Theorem, the statement $(e_3)[\delta]$) the saddle will be weak (more precisely will be an integrable one) if and only if $\mathcal{B}_3 = 0$. Moreover by Remark 6.16 besides the integrable saddle we have a star node. Since $K_2 > 0$ and $\theta_6 = 0$ considering Lemma 6.1 we obtain the following two global configurations of singularities:

$$s, n; \binom{2}{2} \widehat{P}\widehat{P}H - \widehat{P}\widehat{P}H, N^* : \text{Example} \Rightarrow (c = 2, d = -1/2, h = 1, k = -1/2) \\ \text{(if } \mathcal{B}_3 \neq 0);$$

$$s, n^*; \binom{2}{2} \widehat{P}\widehat{P}H - \widehat{P}\widehat{P}H, N^* : \text{Example} \Rightarrow (c = 1, d = 0, h = 1, k = -1) \\ \text{(if } \mathcal{B}_3 = 0).$$

As all possible cases are examined, we have proved that the family of systems with two distinct real finite singularities possesses exactly 151 geometrically distinct global configurations of singularities.

6.3. The family of quadratic differential systems with only one finite singularity which in addition is of multiplicity two. Assuming that quadratic systems (5.1) possess a double singular point, according to [33] (see Table 2) we have to consider two cases: $\widetilde{K} \neq 0$ and $\widetilde{K} = 0$.

6.3.1. *Systems with $\widetilde{K} \neq 0$.* In this case, following [33] (see Table 2), we consider the family of systems

$$\dot{x} = dy + gx^2 + 2dxy, \quad \dot{y} = fy + lx^2 + 2fxy, \quad (6.51)$$

possessing the double singular point $M_{1,2}(0, 0)$. For these systems calculations yield

$$\mu_0 = \mu_1 = 0, \quad \mu_2 = (dl - fg)^2x^2, \quad \kappa = 128d^2(dl - fg), \quad \mathcal{T}_4 = 4d^2f^2(dl - fg)^2. \quad (6.52)$$

Remark 6.17. We observe that the family of systems (6.51) depends on four parameters. However due to a rescaling we can reduce the number of the parameters to two. More precisely since by the condition $\mu_2 \neq 0$ we have $d^2 + f^2 \neq 0$, then we may assume $d, f \in \{(1, 1), (1, 0), (0, 1)\}$ due to the rescaling:

- (i) $(x, y, t) \mapsto (x, fy/d, t/f)$ if $df \neq 0$;
- (ii) $(x, y, t) \mapsto (x, y/d, t)$ if $f = 0$ and
- (iii) $(x, y, t) \mapsto (x, y, t/f)$ if $d = 0$.

Considering (6.52) and $\mu_2 \neq 0$, the condition $d = 0$ is equivalent to $\kappa = 0$ and in the case $\kappa \neq 0$ the condition $f = 0$ is equivalent to $\mathcal{T}_4 = 0$.

The case $\kappa \neq 0$.

The subcase $\mathcal{T}_4 \neq 0$. Then we have $df \neq 0$ and considering Remark 6.17 we may assume $d = f = 1$. So we obtain the 2-parameter family of systems

$$\dot{x} = y + gx^2 + 2xy, \quad \dot{y} = y + lx^2 + 2xy, \quad (6.53)$$

for which calculations yield

$$\begin{aligned} \mu_0 = \mu_1 = 0, \quad \mu_2 &= (g-l)^2x^2, \quad \tilde{K} = 4(g-l)x^2, \quad G_8 = 2(g-l)^2, \\ \mathcal{T}_4 &= 4(g-l)^2 = G_1, \quad \kappa = 128(l-g), \quad \eta = 4[(g+2)^2 + 8(l-g)], \\ \tilde{M} &= -8[(g-2)^2 + 6l]x^2 + 16(2-g)xy - 32y^2. \end{aligned}$$

Remark 6.18. We observe that $\tilde{M} \neq 0$ and $\mu_2 > 0$. Moreover the condition $\kappa > 0$ implies $\eta > 0$.

As $G_8G_1 \neq 0$ according to [5] (see Table 1, line 171) the double finite singular point is a saddle-node.

(1) *The possibility $\kappa < 0$.* As $\tilde{M} \neq 0$ and $\mu_2 > 0$, by Lemma 6.1 we get the following three global configurations of singularities:

$$\begin{aligned} \overline{s\bar{n}}_{(2)}; \overline{\binom{2}{1}}N, \textcircled{C}, \textcircled{C} : \text{Example} &\Rightarrow (g=0, l=-1) \quad (\text{if } \eta < 0); \\ \overline{s\bar{n}}_{(2)}; \overline{\binom{2}{1}}N, S, N^\infty : \text{Example} &\Rightarrow (g=0, l=-1/4) \quad (\text{if } \eta > 0); \\ \overline{s\bar{n}}_{(2)}; \overline{\binom{0}{2}}SN, \overline{\binom{2}{1}}N : \text{Example} &\Rightarrow (g=0, l=-1/2) \quad (\text{if } \eta = 0). \end{aligned}$$

(2) *The possibility $\kappa > 0$.* By Remark 6.18 we have $\eta > 0$ and according to Lemma 6.1 we arrive at the configuration

$$\overline{s\bar{n}}_{(2)}; \overline{\binom{2}{1}}S, N^f, N^f : \text{Example} \Rightarrow (g=0, l=1).$$

The subcase $\mathcal{T}_4 = 0$. Then we have $d \neq 0$, $f = 0$ and considering Remark 6.17 we may assume $d = 1$. So we obtain the 2-parameter family of systems:

$$\dot{x} = y + gx^2 + 2xy, \quad \dot{y} = lx^2, \quad (6.54)$$

for which calculations yield

$$\begin{aligned} \mu_0 = \mu_1 = 0, \quad \mu_2 &= l^2x^2, \quad \tilde{K} = -4lx^2, \quad G_8 = 2l^2, \quad G_1 = 0, \\ \kappa &= 128l, \quad \eta = 4(8l + g^2), \quad \tilde{M} = -8(6cl + g^2)x^2 - 16gxy - 32y^2. \end{aligned} \quad (6.55)$$

As $G_8 \neq 0$ and $G_1 = 0$ according to [5] (see Table 1, line 175) the double finite singular point is a cusp.

(1) *The possibility $\kappa < 0$.* As $\tilde{M} \neq 0$ and $\mu_2 > 0$, by Lemma 6.1 we get the following three global configurations of singularities:

$$\widehat{c\bar{p}}_{(2)}; \overline{\binom{2}{1}}N, \textcircled{C}, \textcircled{C} : \text{Example} \Rightarrow (g=2, l=-1) \quad (\text{if } \eta < 0);$$

$$\begin{aligned} \widehat{cp}_{(2)}; \overline{\binom{2}{1}}N, S, N^\infty : \text{Example} &\Rightarrow (g = 2, l = -1/4) \quad (\text{if } \eta > 0); \\ \widehat{cp}_{(2)}; \overline{\binom{0}{2}}SN, \overline{\binom{2}{1}}N : \text{Example} &\Rightarrow (g = 2, l = -1/2) \quad (\text{if } \eta = 0). \end{aligned}$$

(2) *The possibility* $\kappa > 0$. We observe that the condition $\kappa > 0$ implies $l > 0$ and then $\eta = 4(8l + g^2) > 0$. So considering Lemma 6.1 we arrive at the global configuration of singularities

$$\widehat{cp}_{(2)}; \overline{\binom{2}{1}}S, N^f, N^f : \text{Example} \Rightarrow (g = 1, l = 1).$$

The case $\kappa = 0$. Then for systems (6.51) we have $d = 0$ and by Remark 6.17 we may assume $f = 1$. So we get the family of systems

$$\dot{x} = gx^2, \quad \dot{y} = y + lx^2 + 2xy, \quad (6.56)$$

for which calculations yield

$$\begin{aligned} \mu_0 = \mu_1 = 0, \quad \mu_2 = g^2x^2, \quad \widetilde{K} = 4gx^2, \quad \eta = \kappa = G_8 = 0, \quad K_2 = 0, \\ \widetilde{L} = 8g(g-2)x^2, \quad \widetilde{M} = -8(g-2)^2x^2, \quad C_2 = -lx^3 + (g-2)x^2y. \end{aligned} \quad (6.57)$$

As $G_8 = 0$ and $\widetilde{K} \neq 0$ according to [5] (see Table 1, line 172) the double finite singular point is a saddle-node.

The subcase $\widetilde{K} < 0$. Then $g < 0$ and this implies $\widetilde{M} \neq 0$. As $\mu_2 > 0$ and $K_2 = 0$ considering Lemma 6.1 we obtain the configuration

$$\overline{sn}_{(2)}; \overline{\binom{2}{2}}\widehat{P}H - \widehat{P}H, N^f : \text{Example} \Rightarrow (g = -1, l = 0).$$

The subcase $\widetilde{K} > 0$. In view of Lemma 6.1 we consider two possibilities: $\widetilde{L} \neq 0$ and $\widetilde{L} = 0$.

(1) *The possibility* $\widetilde{L} \neq 0$. Then $g - 2 \neq 0$ and we have $\widetilde{M} \neq 0$. So taking into account the conditions $\mu_2 > 0$ and $K_2 = 0$, by Lemma 6.1 we get the following two global configurations of singularities:

$$\begin{aligned} \overline{sn}_{(2)}; \overline{\binom{2}{2}}\widehat{P}E - \widehat{P}E, S : \text{Example} &\Rightarrow (g = 1, l = 0) \quad (\text{if } \widetilde{L} < 0); \\ \overline{sn}_{(2)}; \overline{\binom{2}{2}}\widehat{P}H - \widehat{P}H, N^\infty : \text{Example} &\Rightarrow (g = 3, l = 0) \quad (\text{if } \widetilde{L} > 0). \end{aligned}$$

(2) *The possibility* $\widetilde{L} = 0$. In this case $g = 2$ and this implies $\widetilde{M} = 0$. As $\mu_2 > 0$ and $K_2 = 0$, by Lemma 6.1 we arrive at the following two global configurations of singularities

$$\begin{aligned} \overline{sn}_{(2)}; \overline{\binom{2}{3}}HE - \widehat{P}\widehat{P} : \text{Example} &\Rightarrow (g = 2, l = 1) \quad (\text{if } C_2 \neq 0); \\ \overline{sn}_{(2)}; [\infty; N^d] : \text{Example} &\Rightarrow (g = 2, l = 0) \quad (\text{if } C_2 = 0). \end{aligned}$$

6.3.2. Systems with $\tilde{K} = 0$. In this case according to [33] (see Table 2) we consider the family of systems

$$\dot{x} = cx + dy, \quad \dot{y} = lx^2 + 2mxy + ny^2, \quad 0 \neq c^2n - 2cdm + d^2l \equiv \mathcal{Z}, \quad (6.58)$$

for which we calculate

$$\begin{aligned} \mu_0 = \mu_1 = \kappa = 0, \quad \mu_2 = \mathcal{Z}(lx^2 + 2mxy + ny^2), \quad \tilde{K} = 0, \\ \tilde{L} = 8n(lx^2 + 2mxy + ny^2), \quad \eta = 4n^2(m^2 - ln), \\ \theta_2 = -d(m^2 - ln), \quad \tilde{M} = -8(4m^2 - 3ln)x^2 - 16mnxy - 8n^2y^2, \\ G_8 = 2n(ln - m^2)\mathcal{Z}, \quad G_1 = 4c^2n(ln - m^2)\mathcal{Z} = \mathcal{T}_4. \end{aligned} \quad (6.59)$$

The case $\tilde{L} \neq 0$. We consider two subcases: $\eta \neq 0$ and $\eta = 0$.

The subcase $\eta \neq 0$. In this case $G_8 \neq 0$ and we examine two possibilities: $\mathcal{T}_4 \neq 0$ and $\mathcal{T}_4 = 0$.

(1) The possibility $\mathcal{T}_4 \neq 0$. Then we have $cn \neq 0$ and due to the rescaling $(x, y, t) \mapsto (x, cy/n, t/c)$ we may assume $c = n = 1$. So we get the family of systems

$$\dot{x} = x + dy, \quad \dot{y} = lx^2 + 2mxy + y^2, \quad 0 \neq 1 - 2dm + d^2l \equiv \mathcal{Z}', \quad (6.60)$$

where we may consider $d \in \{0, 1\}$ due to the rescaling $x \rightarrow dx$ if $d \neq 0$. For these systems we have

$$\begin{aligned} \mathcal{T}_4 = 4(l - m^2)\mathcal{Z}' = G_1 = 2G_8, \quad \eta = 4(m^2 - l), \quad \theta_2 = d(l - m^2), \\ \mu_2 = \mathcal{Z}'(lx^2 + 2mxy + y^2), \quad \tilde{L} = 8(lx^2 + 2mxy + y^2). \end{aligned}$$

As $G_8G_1 \neq 0$ according to [5] (see Table 1, line 171) the finite singular point is a saddle-node.

(a) The case $\eta < 0$. Considering Lemma 6.1 we get the following two global configurations of singularities:

$$\begin{aligned} \overline{s\bar{n}}_{(2)}; N^d, \begin{pmatrix} 1 \\ 1 \end{pmatrix} \odot, \begin{pmatrix} 1 \\ 1 \end{pmatrix} \odot : \text{Example} \Rightarrow (d = 1, l = 1, m = 0) \quad (\text{if } \theta_2 \neq 0); \\ \overline{s\bar{n}}_{(2)}; N^*, \begin{pmatrix} 1 \\ 1 \end{pmatrix} \odot, \begin{pmatrix} 1 \\ 1 \end{pmatrix} \odot : \text{Example} \Rightarrow (d = 0, l = 1, m = 0) \quad (\text{if } \theta_2 = 0). \end{aligned}$$

(b) The case $\eta > 0$. We observe, that $\text{sign}(\mu_2\tilde{L}) = \text{sign}(\mathcal{Z}')$. Moreover if $d = 0$ we obtain $\mathcal{Z}' = 1 > 0$. So considering Lemma 6.1 we arrive at the following three global configurations of singularities:

$$\begin{aligned} \overline{s\bar{n}}_{(2)}; \overline{\begin{pmatrix} 1 \\ 1 \end{pmatrix}} SN, \overline{\begin{pmatrix} 1 \\ 1 \end{pmatrix}} SN, N^d : \text{Example} \Rightarrow (d = 1, l = 0, m = 1) \quad (\text{if } \mu_2\tilde{L} < 0); \\ \overline{s\bar{n}}_{(2)}; \overline{\begin{pmatrix} 1 \\ 1 \end{pmatrix}} SN, \overline{\begin{pmatrix} 1 \\ 1 \end{pmatrix}} NS, N^d : \text{Example} \Rightarrow (d = 1, l = 0, m = -1) \\ (\text{if } \mu_2\tilde{L} > 0, \theta_2 \neq 0); \\ \overline{s\bar{n}}_{(2)}; \overline{\begin{pmatrix} 1 \\ 1 \end{pmatrix}} SN, \overline{\begin{pmatrix} 1 \\ 1 \end{pmatrix}} NS, N^* : \text{Example} \Rightarrow (d = 0, l = 0, m = 1) \\ (\text{if } \mu_2\tilde{L} > 0, \theta_2 = 0). \end{aligned}$$

(2) *The possibility $\mathcal{T}_4 = 0$.* By (6.59) due to the condition $\eta \neq 0$ we obtain $c = 0$ and then $dl n \neq 0$. So via the rescaling $(x, y, t) \mapsto (dx/n, y/n, t)$ we may assume $n = d = 1$ and we arrive at the family of systems

$$\dot{x} = y, \quad \dot{y} = lx^2 + 2mxy + y^2. \tag{6.61}$$

We observe that we may assume $m \in \{0, 1\}$ due to the rescaling $(x, y, t) \mapsto (x, my, t/m)$ if $m \neq 0$. For these systems we calculate

$$G_1 = 0, \quad G_8 = 2l(l - m^2), \quad \eta = 4(m^2 - l), \quad \theta_2 = l - m^2, \\ \mu_2 = l(lx^2 + 2mxy + y^2), \quad \tilde{L} = 8(lx^2 + 2mxy + y^2).$$

So the condition $\eta\mu_2 \neq 0$ implies $G_8 \neq 0$ and due to $G_1 = 0$ by [5] (see Table 1, line 175) the double finite singular point is a cusp.

On the other hand we have $\theta_2 \neq 0$ and $\text{sign}(\mu_2\tilde{L}) = \text{sign}(l)$. So considering Lemma 6.1 we get the following three global configurations of singularities:

$$\widehat{cp}_{(2)}; N^d, \begin{pmatrix} 1 \\ 1 \end{pmatrix} \odot, \begin{pmatrix} 1 \\ 1 \end{pmatrix} \odot : \text{Example} \Rightarrow (l = 1, m = 0) \quad (\text{if } \eta < 0); \\ \widehat{cp}_{(2)}; \overline{\begin{pmatrix} 1 \\ 1 \end{pmatrix}} SN, \overline{\begin{pmatrix} 1 \\ 1 \end{pmatrix}} SN, N^d : \text{Example} \Rightarrow (l = -1, m = 1) \quad (\text{if } \eta > 0, \mu_2\tilde{L} < 0); \\ \widehat{cp}_{(2)}; \overline{\begin{pmatrix} 1 \\ 1 \end{pmatrix}} SN, \overline{\begin{pmatrix} 1 \\ 1 \end{pmatrix}} NS, N^d : \text{Example} \Rightarrow (l = 1, m = 2) \quad (\text{if } \eta > 0, \mu_2\tilde{L} > 0).$$

The subcase $\eta = 0$. As $n \neq 0$ (due to $\tilde{L} \neq 0$) we may assume $n = 1$ due to a rescaling. So considering (6.59) the condition $\eta = 0$ gives $m^2 - l = 0$ and we obtain $l = m^2$. Then for systems (6.58) we have

$$\mu_2 = (c - dm)^2(mx + y)^2, \quad \kappa_1 = 32m(c - dm),$$

and as $\mu_2 \neq 0$ the condition $\kappa_1 = 0$ is equivalent to $m = 0$.

(1) *The possibility $\kappa_1 \neq 0$.* Then $m \neq 0$ and we may assume $m = 1$ due to the rescaling $x \rightarrow x/m$. Therefore we arrive at the family of systems

$$\dot{x} = cx + dy, \quad \dot{y} = (x + y)^2, \tag{6.62}$$

for which we calculate

$$\eta = \kappa = G_8 = 0, \quad \mu_2 = (c - d)^2(x + y)^2, \quad \tilde{K} = \tilde{N} = 0, \\ \tilde{L} = 8(x + y)^2, \quad \tilde{M} = -8(x + y)^2, \quad \theta_5 = 96(c - d)d(x + y)^3, \\ \kappa_1 = 32(c - d), \quad F_3 = 24c(c - d)(x + y), \quad \mathcal{B}_1 = 2c^2(c - d)^2. \tag{6.63}$$

(a) *The case $\mathcal{B}_1 \neq 0$.* Then $c \neq 0$ and we may assume $c = 1$ due to the rescaling $(x, y, t) \mapsto (cx, cy, t/c)$. We observe that in this case $F_3 \neq 0$ and as $G_8 = \tilde{K} = \tilde{N} = 0$, according to [5] (see Table 1, line 174), the finite singular point is a saddle-node.

On the other hand we have $\eta = \kappa = \tilde{K} = 0$ and $\tilde{M}\tilde{L}\kappa_1 \neq 0$. Therefore considering Lemma 6.1 we obtain the following two global configurations of singularities:

$$\overline{sn}_{(2)}; \overline{\begin{pmatrix} 2 \\ 2 \end{pmatrix}} \widehat{P}_\lambda \widehat{P}H_\lambda - H, N^d : \text{Example} \Rightarrow (c = 1, d = 2) \quad (\text{if } \theta_5 \neq 0); \\ \overline{sn}_{(2)}; \overline{\begin{pmatrix} 2 \\ 2 \end{pmatrix}} \widehat{P}_\lambda \widehat{P}H_\lambda - H, N^* : \text{Example} \Rightarrow (c = 1, d = 0) \quad (\text{if } \theta_5 = 0).$$

(b) *The case $\mathcal{B}_1 = 0$.* Then $c = 0$ and this implies $F_3 = 0$. So by [5] (see Table 1, line 177) the double finite singular point is a cusp. As in this case $\theta_5 = -96d^2(x+y)^3 \neq 0$ (due to $\mu_2 = d^2(x+y)^2 \neq 0$), considering (6.63) and Lemma 6.1 we get the configuration

$$\widehat{c\mathcal{P}}_{(2)}; \left(\widehat{\begin{matrix} 2 \\ 2 \end{matrix}}\right) \widehat{P}_\lambda \widehat{P}H_\lambda - H, N^d : \text{Example} \Rightarrow (c = 0, d = 1).$$

(1) *The possibility $\kappa_1 = 0$.* In this case we have $m = 0$ and this leads to the family of systems

$$\dot{x} = cx + dy, \quad \dot{y} = y^2, \quad (6.64)$$

for which we calculate

$$\mu_2 = c^2y^2, \quad F_3 = 24c^2y, \quad K_2 = 0, \quad \theta_6 = -8dy^4$$

and therefore the condition $\mu_2 \neq 0$ implies $F_3 \neq 0$. So the double finite singularity is a saddle-node and considering Lemma 6.1 we obtain the following two global configurations of singularities:

$$\begin{aligned} \overline{s\mathcal{n}}_{(2)}; \left(\begin{matrix} 2 \\ 2 \end{matrix}\right) \widehat{P}H - \widehat{P}H, N^d : \text{Example} \Rightarrow (c = 1, d = 1) \quad (\text{if } \theta_6 \neq 0); \\ \overline{s\mathcal{n}}_{(2)}; \left(\begin{matrix} 2 \\ 2 \end{matrix}\right) \widehat{P}H - \widehat{P}H, N^* : \text{Example} \Rightarrow (c = 1, d = 0) \quad (\text{if } \theta_6 = 0). \end{aligned}$$

The case $\tilde{L} = 0$. Then for systems (6.58) we have $n = 0$ and then $d \neq 0$ (otherwise we get degenerate systems). So we may assume $d = 1$ (due to a rescaling) and we obtain the family of systems

$$\dot{x} = cx + y, \quad \dot{y} = lx^2 + 2mxy, \quad (6.65)$$

for which we calculate

$$\begin{aligned} \eta = \kappa = G_8 = \tilde{K} = \tilde{L} = 0, \quad \mu_2 = (l - 2cm)x(lx + 2my), \quad \tilde{N} = -4m^2x^2, \\ \tilde{M} = -32m^2x^2, \quad G_{10} = c^2m^3(l - 2cm), \quad \mathcal{B}_1 = 2c^2m(l - 2cm). \end{aligned} \quad (6.66)$$

The subcase $\tilde{M} \neq 0$. Then $m \neq 0$ and we may assume $m = 1$ due to the rescaling $(x, y, t) \mapsto (x/m, y/m, t)$. Moreover for systems above with $m = 1$ we may consider $c \in \{0, 1\}$ due to the rescaling $(x, y, t) \mapsto (cx, c^2y, t/c)$ if $c \neq 0$.

Therefore we have $\tilde{N} \neq 0$ and by [5] (see Table 1, lines 173,176) the finite singular point is a saddle-node if $G_{10} \neq 0$ and it is a cusp if $G_{10} = 0$. We observe that the condition $G_{10} = 0$ is equivalent to $\mathcal{B}_1 = 0$. So as $\tilde{M} \neq 0$ and $\tilde{L} = 0$, considering Lemma 6.1 we obtain the following two global configurations of singularities:

$$\begin{aligned} \overline{s\mathcal{n}}_{(2)}; \left(\overline{\begin{matrix} 1 \\ 2 \end{matrix}}\right) \widehat{P}_\lambda E\widehat{P}_\lambda - H, \left(\overline{\begin{matrix} 1 \\ 1 \end{matrix}}\right) SN : \text{Example} \Rightarrow (c = 1, m = 1, l = 1) \\ (\text{if } \mathcal{B}_1 \neq 0); \\ \widehat{c\mathcal{P}}_{(2)}; \left(\widehat{\begin{matrix} 1 \\ 2 \end{matrix}}\right) \widehat{P}_\lambda E\widehat{P}_\lambda - H, \left(\widehat{\begin{matrix} 1 \\ 1 \end{matrix}}\right) SN : \text{Example} \Rightarrow (c = 0, m = 1, l = 1) \\ (\text{if } \mathcal{B}_1 = 0). \end{aligned}$$

The subcase $\widetilde{M} = 0$. Then $m = 0$ and $l \neq 0$ (otherwise we get degenerate systems). Hence we may assume $l = 1$ due to the rescaling $(x, y, t) \mapsto (x/l, y/l, t)$. Then for systems (6.65) with $m = 0$ and $l = 1$ considering (6.66) we obtain

$$\widetilde{M} = \widetilde{K} = \widetilde{N} = G_8 = 0, \quad C_2 = -x^3, \quad F_3 = -24cx, \quad \mathcal{B}_4 = 6cx^2(cx + y).$$

So by [5] (see Table 1, lines 174,177) the finite singular point is a saddle–node if $F_3 \neq 0$ and it is a cusp if $F_3 = 0$. We observe that the condition $F_3 = 0$ is equivalent to $\mathcal{B}_4 = 0$. Considering the conditions above according to Lemma 6.1 we obtain the following two global configurations of singularities

$$\begin{aligned} \overline{sn}_{(2)}; \begin{pmatrix} 2 \\ 3 \end{pmatrix} \widehat{P}_\wedge \widehat{P} - \widehat{P}_\wedge \widehat{P} : \text{Example} &\Rightarrow (c = 1, m = 0, l = 1) \quad (\text{if } \mathcal{B}_4 \neq 0); \\ \widehat{cp}_{(2)}; \begin{pmatrix} 2 \\ 3 \end{pmatrix} \widehat{P}_\wedge \widehat{P} - \widehat{P}_\wedge \widehat{P} : \text{Example} &\Rightarrow (c = 0, m = 0, l = 1) \quad (\text{if } \mathcal{B}_4 = 0). \end{aligned}$$

Since all possibilities are examined for this case, we have proved that the family of systems with a single finite real singular point which is of multiplicity two possesses exactly 30 geometrically distinct global configurations of singularities.

With this the whole proof of our Main Theorem is complete.

Acknowledgments. The authors are grateful to the anonymous referee for his/her comments and suggestions.

The first two authors are partially supported by a MINECO/FEDER grant number MTM2008-03437 and an AGAUR grant number 2009SGR 410. The second author is also supported by ICREA Academia and FP7-PEOPLE2012-IRSES number 318999. The second and fourth authors are partially supported by the grant FP7-PEOPLE-2012-IRSES-316338. The third author is supported by NSERC-RGPIN (8528-2010). The fourth author is also supported by grant 12.839.08.05F from SCSTD of ASM and partially by NSERC-RGPIN (8528-2010).

REFERENCES

- [1] J. C. Artés, J. Llibre; *Quadratic Hamiltonian vector fields*, J. Differential Equations, **107** (1994), 80–95.
- [2] J. C. Artés, J. Llibre, D. Schlomiuk; *The geometry of quadratic differential systems with a weak focus of second order*, International J. of Bifurcation and Chaos, **16** (2006), 3127–3194.
- [3] J. C. Artés, J. Llibre, D. Schlomiuk, N. Vulpe; *From topological to geometric equivalence in the classification of singularities at infinity for quadratic vector fields*, Rocky Mountain J. of Math., **43**(2013), No. 6.
- [4] J. C. Artés, J. Llibre, D. Schlomiuk, N. Vulpe; *Configurations of singularities for quadratic differential systems with total finite multiplicity lower than 2*, Bul. Acad. Stiinte Repub. Mold. Mat., **71** (2013), 72–124.
- [5] J. C. Artés, J. Llibre, N. I. Vulpe; *Singular points of quadratic systems: A complete classification in the coefficient space \mathbb{R}^{12}* , International J. of Bifurcation and Chaos, **18** (2008), 313–362.
- [6] J. C. Artés, J. Llibre, N. Vulpe; *Complete geometric invariant study of two classes of quadratic systems*, Electron. J. Differential Equations, **2012** (2012) No. 9, 1–35.
- [7] J. C. Artés, J. Llibre, N. Vulpe; *Quadratic systems with an integrable saddle: A complete classification in the coefficient space \mathbb{R}^{12}* , Nonlinear Analysis, **75** (2012), 5416–5447.
- [8] V. A. Baltag; *Algebraic equations with invariant coefficients in qualitative study of the polynomial homogeneous differential systems*, Bul. Acad. Stiinte Repub. Mold. Mat., **2** (2003), 31–46.

- [9] V. A. Baltag, N. I. Vulpe; *Affine-invariant conditions for determining the number and multiplicity of singular points of quadratic differential systems*, Izv. Akad. Nauk Respub. Moldova Mat., **1** (1993), 39–48.
- [10] V. A. Baltag, N. I. Vulpe; *Total multiplicity of all finite critical points of the polynomial differential system*, Planar nonlinear dynamical systems (Delft, 1995), Differ. Equ. Dyn. Syst., **5** (1997), 455–471.
- [11] D. Bularas, Iu. Calin. L. Timochouk, N. Vulpe; *T-comitants of quadratic systems: A study via the translation invariants*, Delft University of Technology, Faculty of Technical Mathematics and Informatics, Report no. 96-90, 1996; URL: <ftp://ftp.its.tudelft.nl/publications/tech-reports/1996/DUT-TWI-96-90.ps.gz>
- [12] Iu. Calin; *On rational bases of $GL(2, \mathbb{R})$ -comitants of planar polynomial systems of differential equations*, Bul. Acad. Stiinte Repub. Mold. Mat., **2** (2003), 69–86.
- [13] B. Coll; *Qualitative study of some classes of vector fields in the plane*, Ph. D., Universitat Autònoma de Barcelona, (1987), 5–34.
- [14] F. Dumortier, J. Llibre, J. C. Artés; *Qualitative Theory of Planar Differential Systems*, Universitext, Springer–Verlag, New York–Berlin, ISBN: 3-540-32893-9, 2008.
- [15] E. A. González Velasco; *Generic properties of polynomial vector fields at infinity*, Trans. Amer. Math. Soc., **143** (1969), 201–222.
- [16] J. H. Grace, A. Young; *The algebra of invariants*, New York, Stechert, 1941.
- [17] Q. Jiang, J. Llibre; *Qualitative classification of singular points*, Qual. Theory Dyn. Syst., **6** (2005), 87–167.
- [18] J. Llibre, D. Schlomiuk; *Geometry of quadratic differential systems with a weak focus of third order*, Canad. J. of Math., **56** (2004), 310–343.
- [19] P. J. Olver; *Classical Invariant Theory*, London Math. Soc. Student Texts **44**, Cambridge University Press, 1999.
- [20] I. Nikolaev, N. Vulpe; *Topological classification of quadratic systems at infinity*, J. London Math. Soc., **2** (1997), 473–488.
- [21] J. Pal and D. Schlomiuk; *Summing up the dynamics of quadratic Hamiltonian systems with a center*, Canad. J. Math., **56** (1997), 583–599.
- [22] M. N. Popa; *Applications of algebraic methods to differential systems*, Romania, Pitești Univers., The Flower Power Edit., 2004.
- [23] D. Schlomiuk; *Algebraic particular integrals, integrability and the problem of the center*, Trans. Amer. Math. Soc., **338** (1993), 799–841.
- [24] D. Schlomiuk; *Algebraic and Geometric Aspects of the Theory of Polynomial vector fields*, in Bifurcations and periodic Orbits of Vector Fields, Dana Schlomiuk Editor, NATO ASI Series, Series C: Vol.408, Kluwer Academic Publishers, (1993), 429–467.
- [25] D. Schlomiuk, J. Pal; *On the geometry in the neighborhood of infinity of quadratic differential phase portraits with a weak focus*, Qual. Theory Dyn. Syst., **2** (2001), 1–43.
- [26] D. Schlomiuk, N. I. Vulpe; *Geometry of quadratic differential systems in the neighborhood of infinity*, J. Differential Equations, **215** (2005), 357–400.
- [27] D. Schlomiuk, N. I. Vulpe; *Integrals and phase portraits of planar quadratic differential systems with invariant lines of at least five total multiplicity*, Rocky Mountain J. Math., **38** (2008) No. 6, 1–60.
- [28] D. Schlomiuk, N. I. Vulpe; *Integrals and phase portraits of planar quadratic differential systems with invariant lines of total multiplicity four*, Bul. Acad. Stiinte Repub. Mold. Mat., **1** (2008), 27–83.
- [29] D. Schlomiuk, N. I. Vulpe; *The full study of planar quadratic differential systems possessing a line of singularities at infinity*, J. Dynam. Differential Equations, **20** (2008), 737–775.
- [30] D. Schlomiuk, N. I. Vulpe; *Global classification of the planar Lotka-Volterra differential system according to their configurations of invariant straight lines*, J. Fixed Point Theory Appl., **8** (2010), 177–245.
- [31] D. Schlomiuk, N. I. Vulpe; *The Global Topological classification of the Lotka-Volterra quadratic differential systems*, Electron. J. Differential Equations, **2012** (2012) No. 64, 1–69.
- [32] K. S. Sibirskii; *Introduction to the algebraic theory of invariants of differential equations*, Translated from the Russian. Nonlinear Science: Theory and Applications. Manchester University Press, Manchester, 1988.
- [33] N. VULPE; *Characterization of the finite weak singularities of quadratic systems via invariant theory*. Nonlinear Analysis, **74** (2011), No. 4, 6553–6582.

- [34] N. I. Vulpe; *Affine-invariant conditions for the topological discrimination of quadratic systems with a center*, Differential Equations, **19** (1983), 273–280.
- [35] N. I. Vulpe; *Polynomial bases of comitants of differential systems and their applications in qualitative theory* (in Russian), “Știința”, Kishinev, 1986.
- [36] N. Vulpe, M. Lupan; *Quadratic systems with dicritical points*, Bul. Acad. Stiinte Repub. Mold. Mat., **3** (1994), 52–60.
- [37] H. Żołądek; *Quadratic systems with center and their perturbations*, J. Differential Equations, **109** (1994), 223–273.

JOAN C. ARTÉS

DEPARTAMENT DE MATEMÀTIQUES, UNIVERSITAT AUTÒNOMA DE BARCELONA, 08193 BELLATERRA,
BARCELONA, SPAIN

E-mail address: `artes@mat.uab.cat`

JAUME LLIBRE

DEPARTAMENT DE MATEMÀTIQUES, UNIVERSITAT AUTÒNOMA DE BARCELONA, 08193 BELLATERRA,
BARCELONA, SPAIN

E-mail address: `jllibre@mat.uab.cat`

DANA SCHLOMIUK

DÉPARTEMENT DE MATHÉMATIQUES ET DE STATISTIQUES, UNIVERSITÉ DE MONTRÉAL, CANADA

E-mail address: `dasch@dms.umontreal.ca`

NICOLAE VULPE

INSTITUTE OF MATHEMATICS AND COMPUTER SCIENCE, ACADEMY OF SCIENCE OF MOLDOVA, 5
ACADEMIEI STR, CHIȘINĂU, MD-2028, MOLDOVA

E-mail address: `nvulpe@gmail.com`